

Rock Slide

Action/Adventure Scene by Michaela Wadzinski

Scene	Panel
1	1

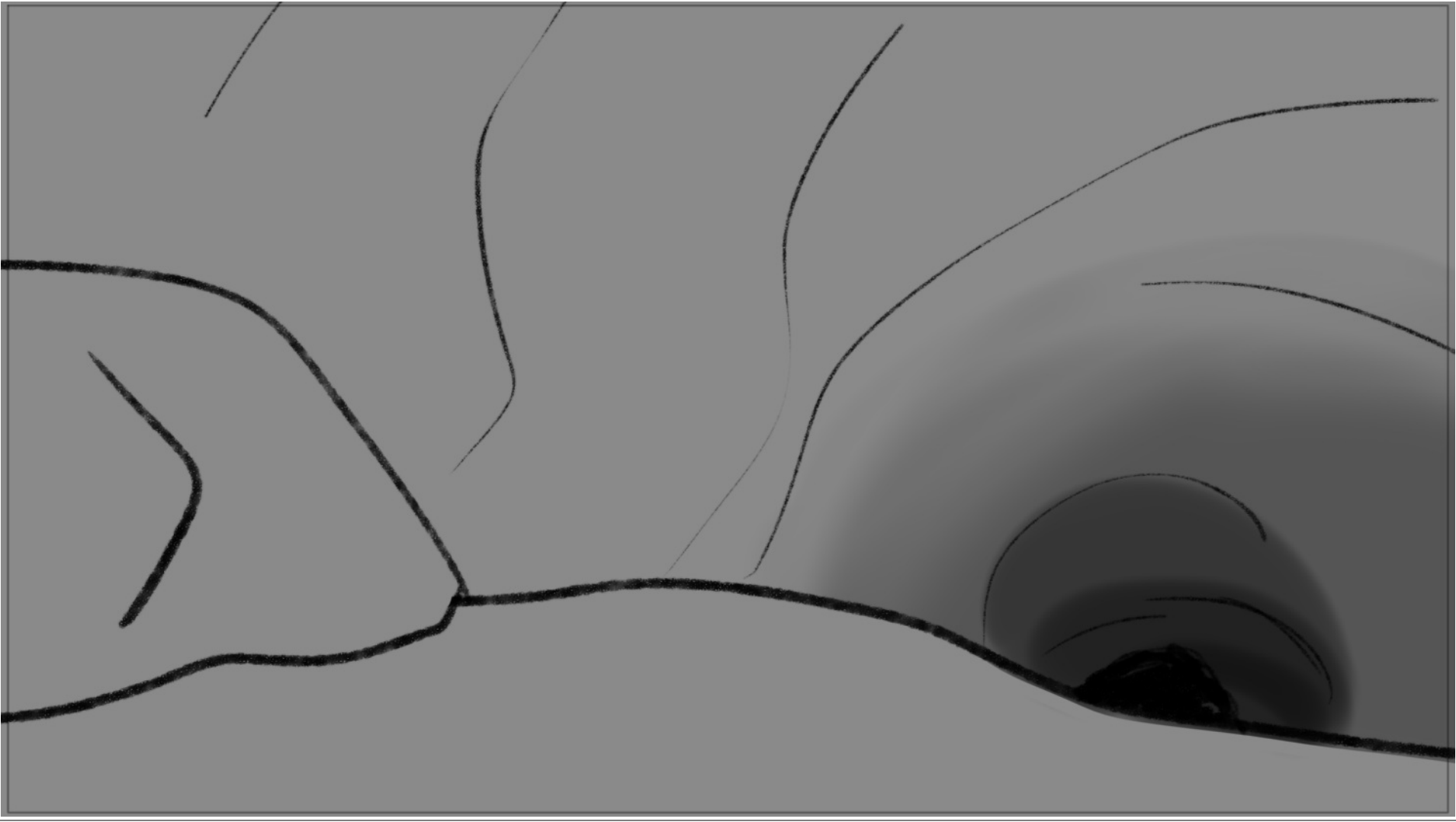

Scene	Panel
1	2

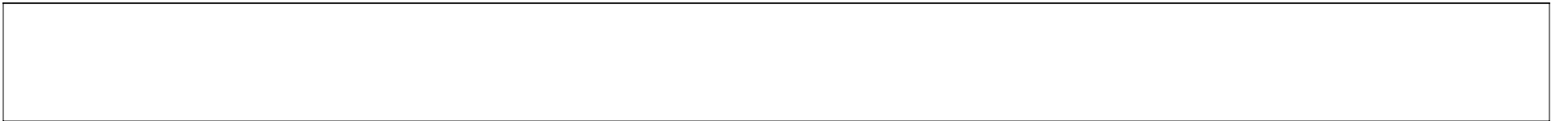
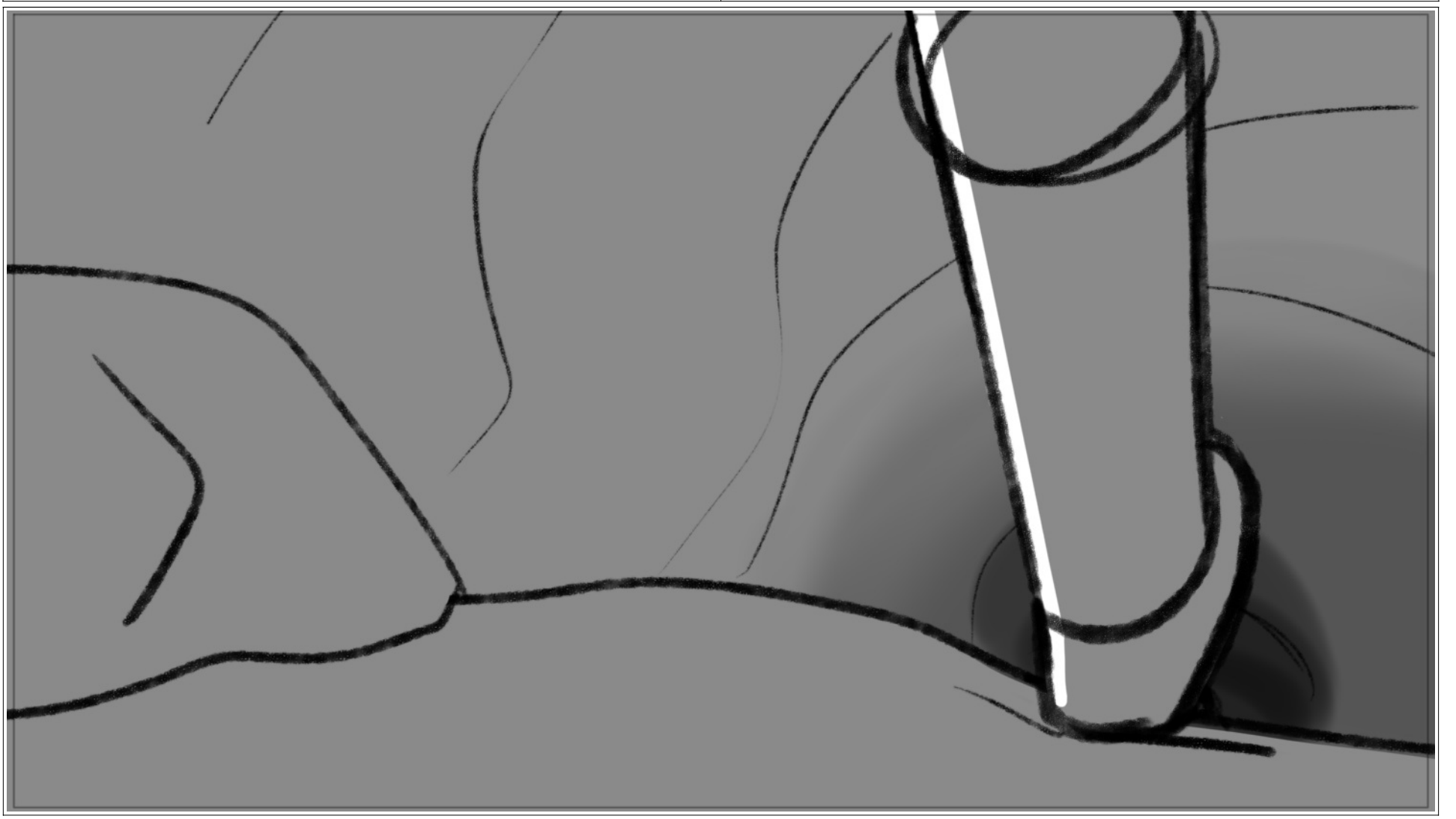

Scene	Panel
1	3

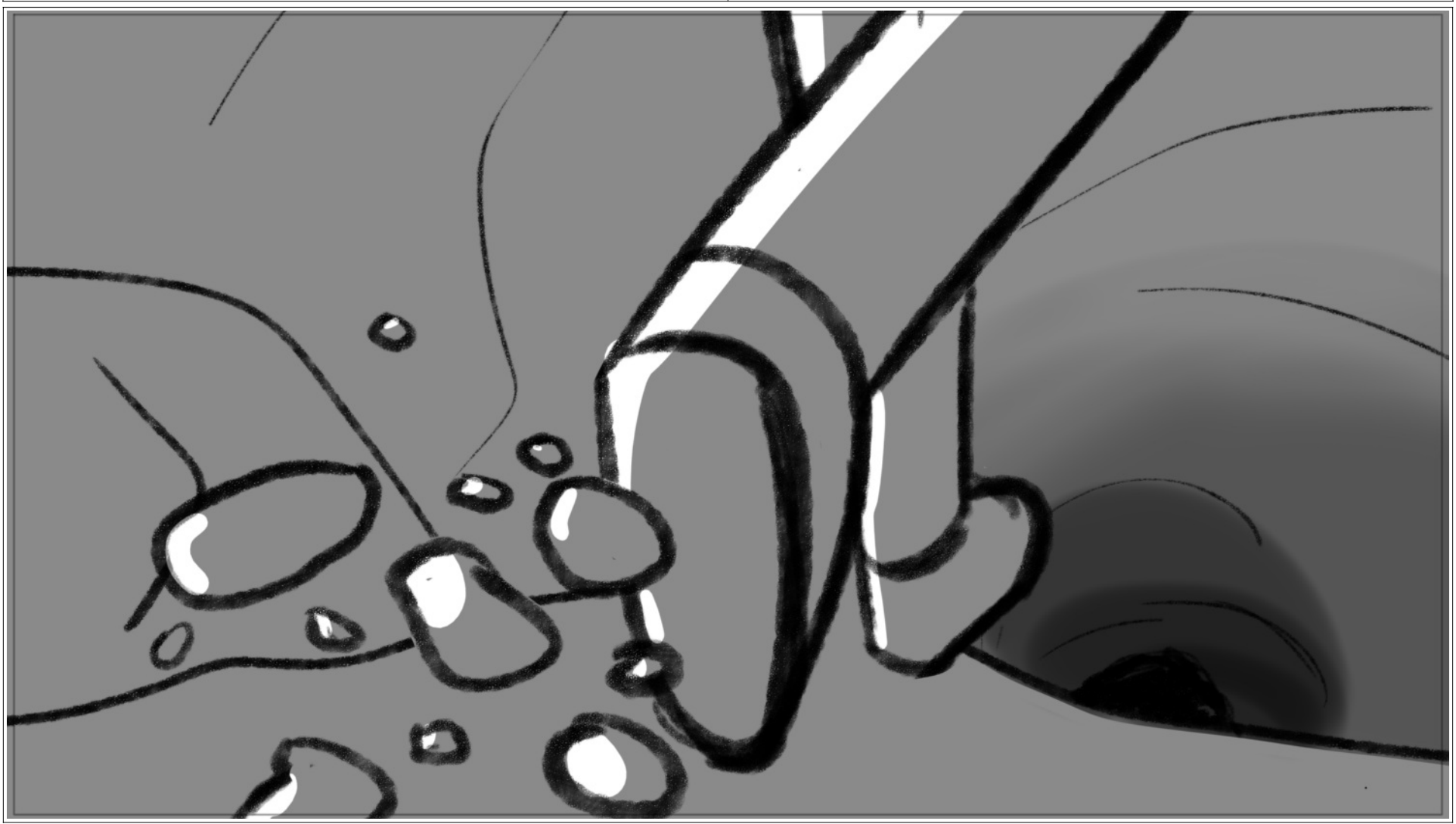

Scene	Panel
2	1

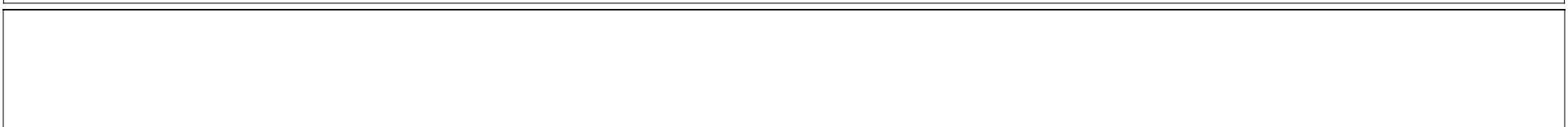
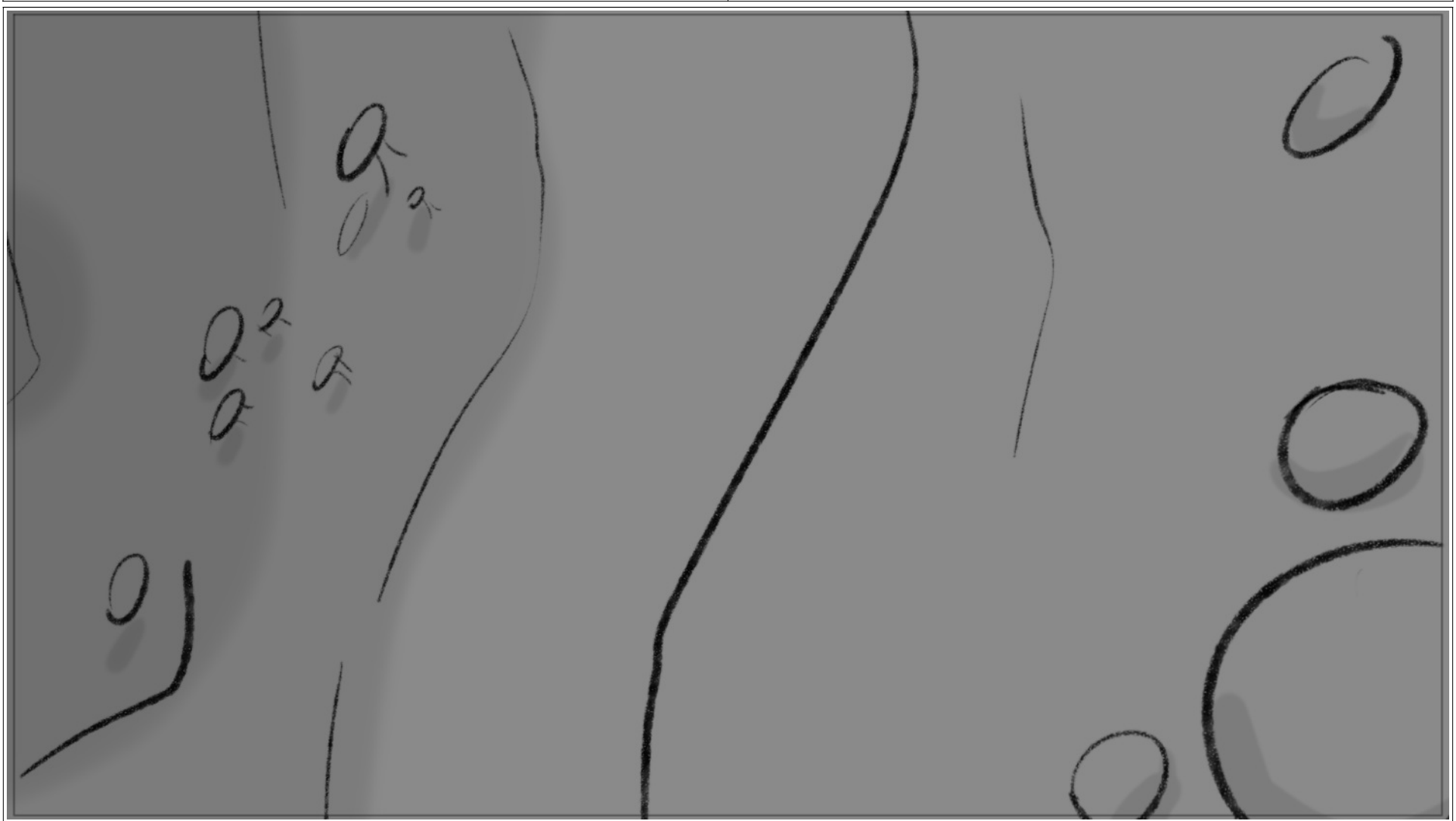

Scene	Panel
2	2

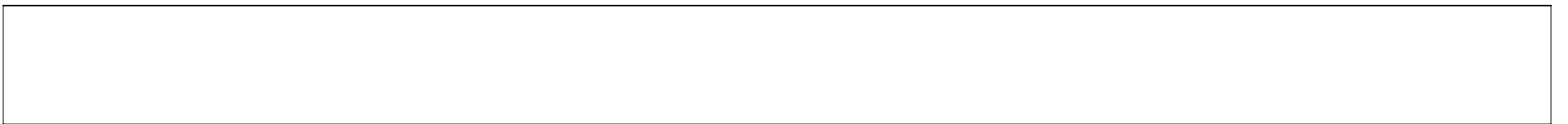
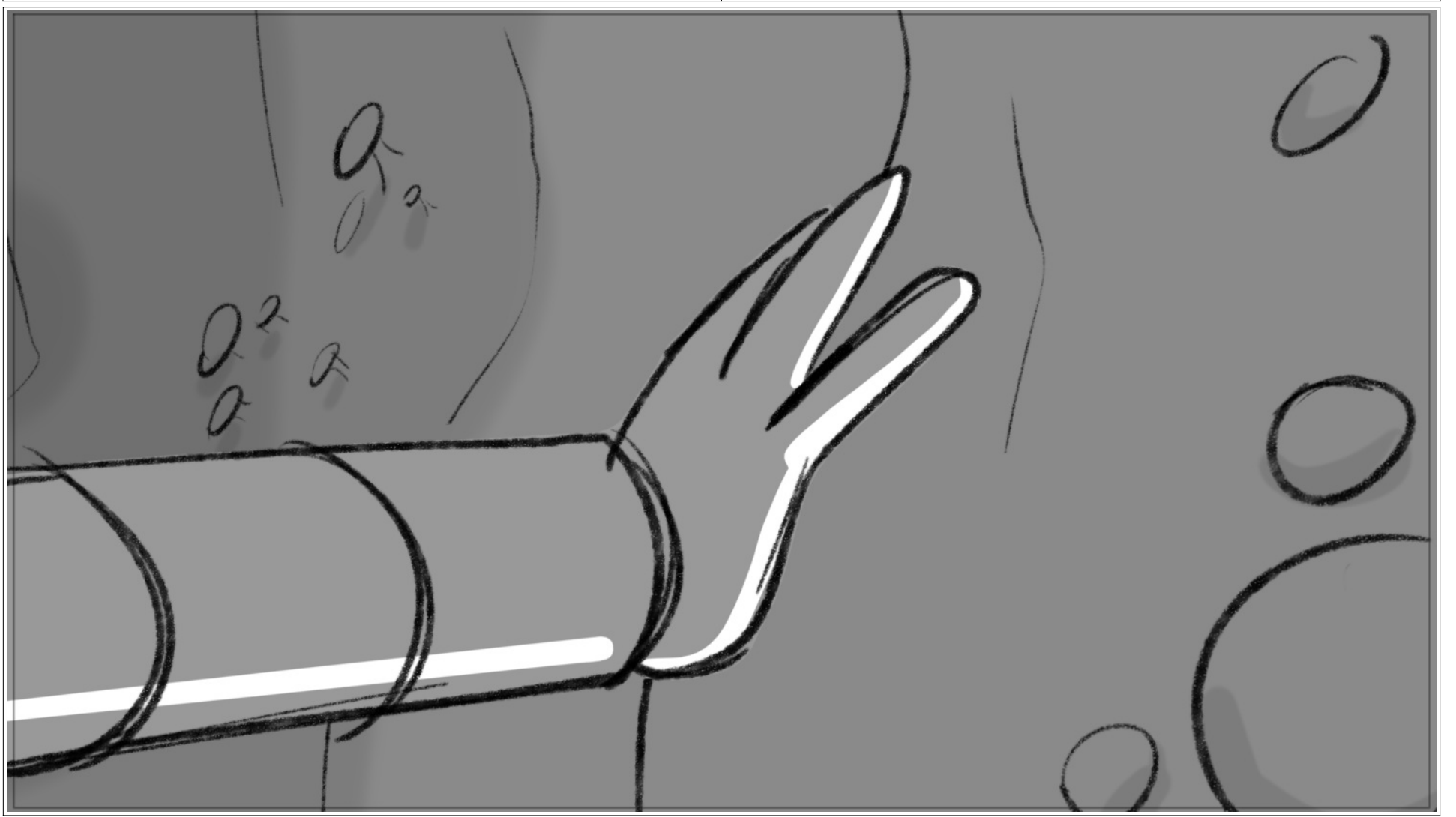

Scene	Panel
2	3



Scene	Panel
2	4

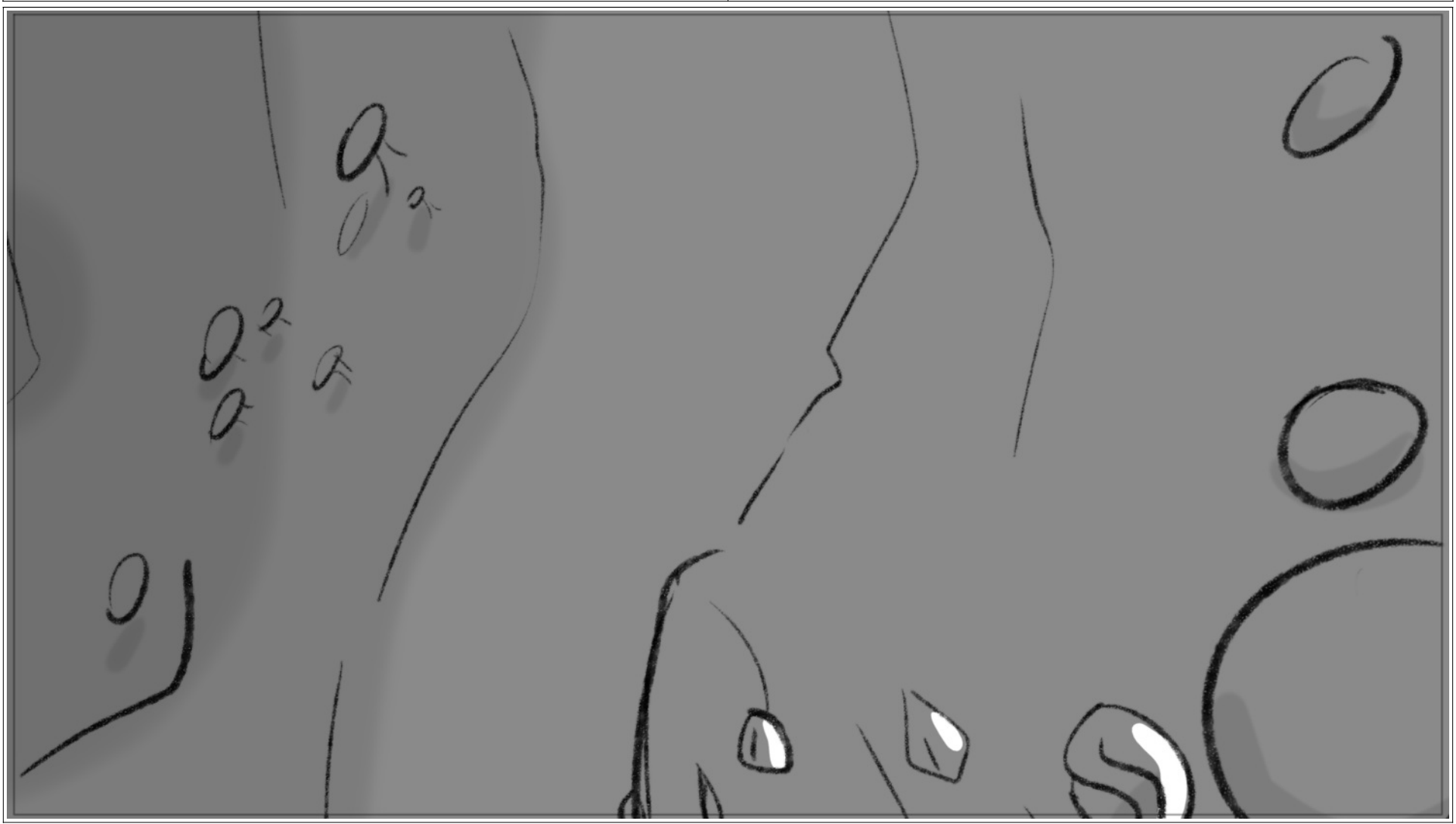

Scene	Panel
3	1



Scene	Panel
3	2

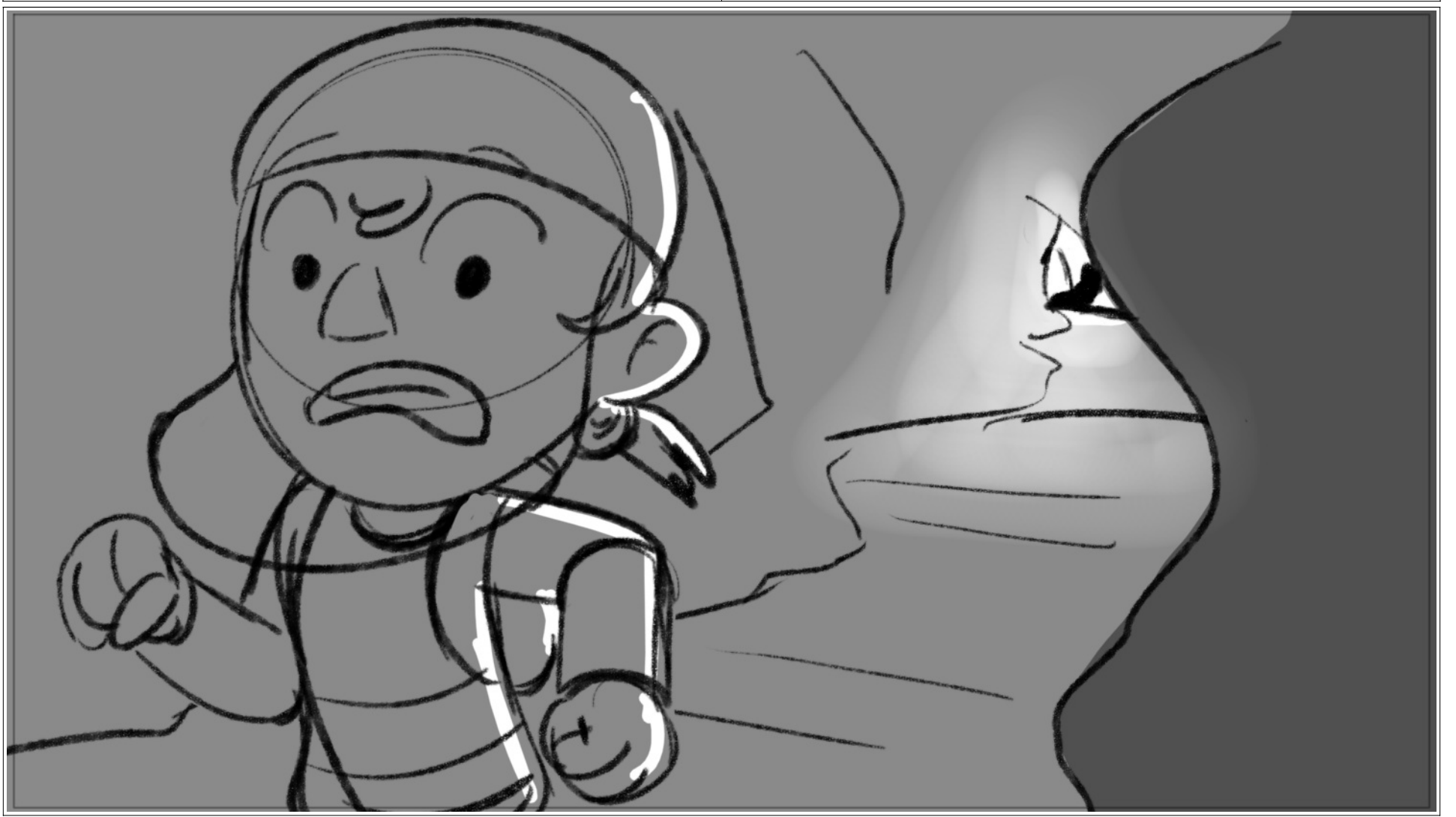

Scene	Panel
3	3

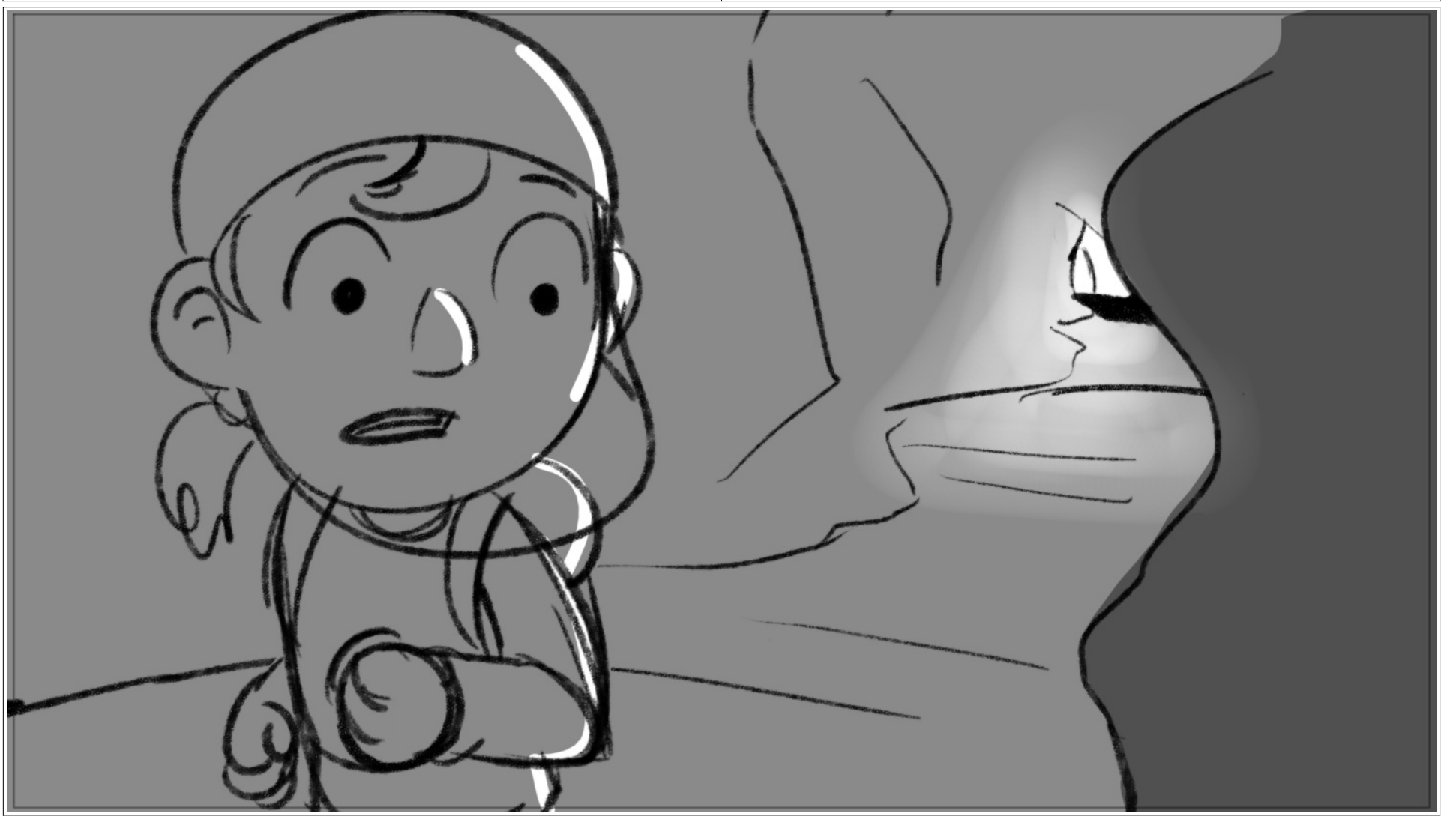

Scene	Panel
3	4

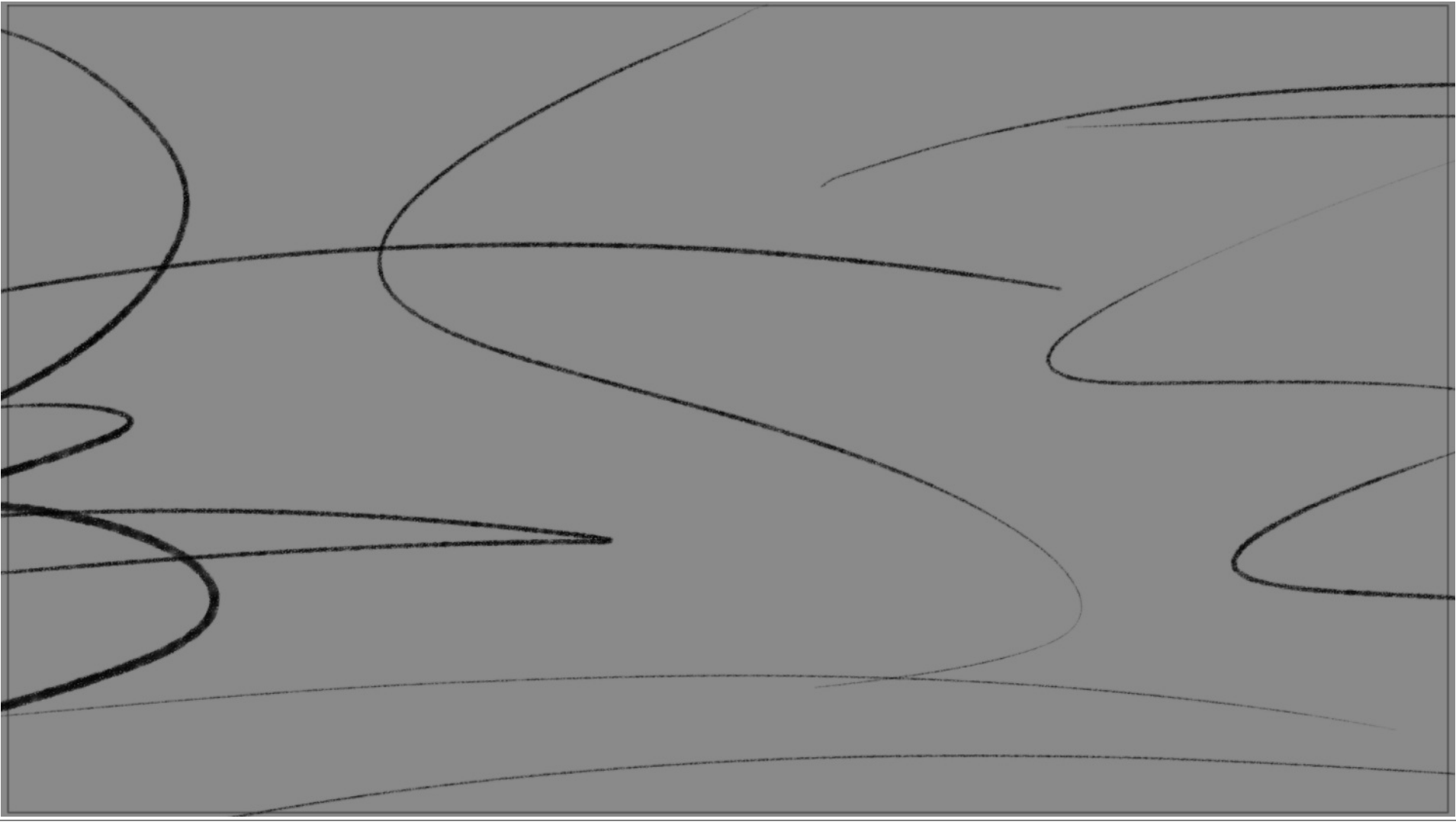

Scene	Panel
3	5

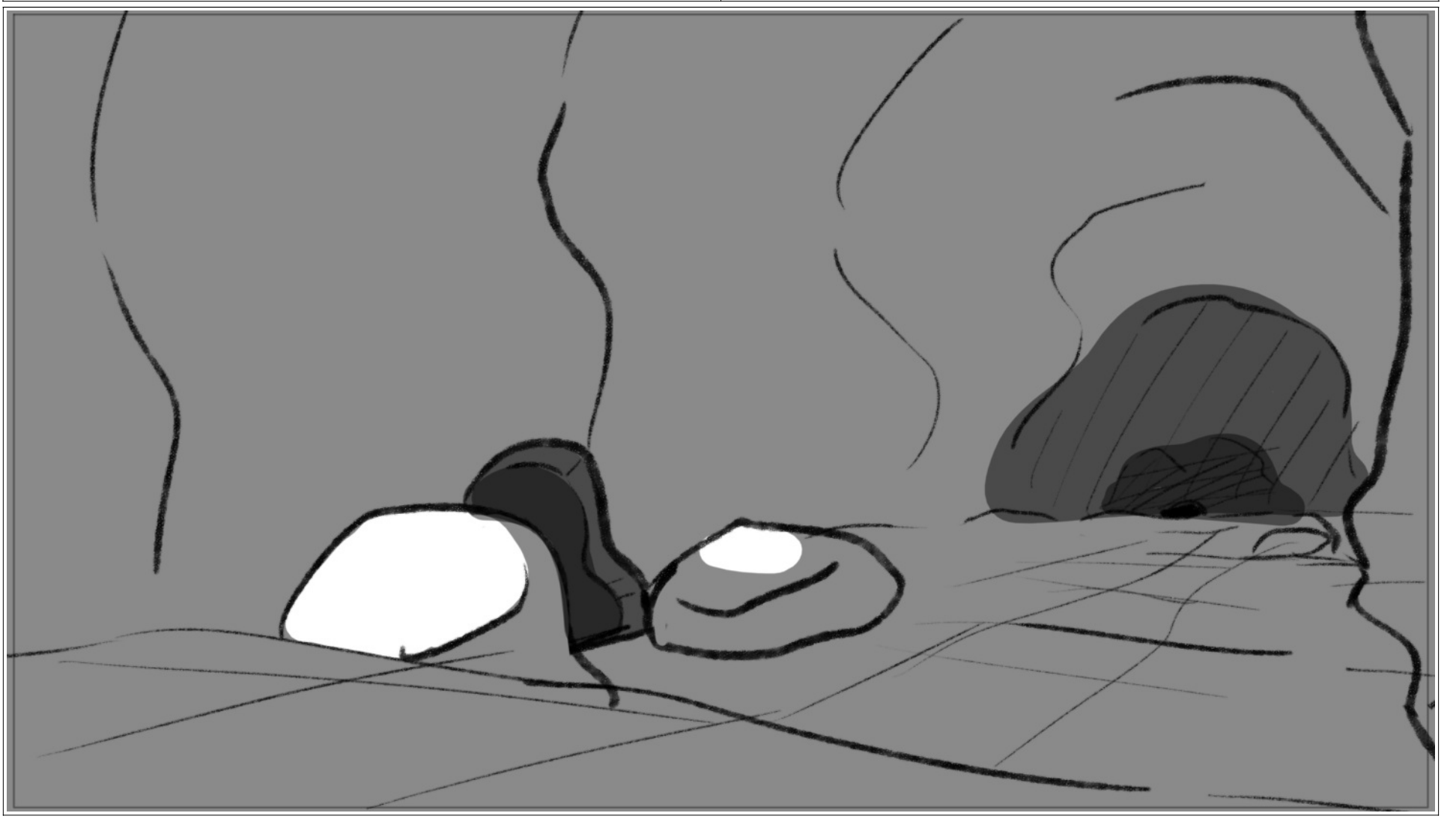

Scene	Panel
3	6

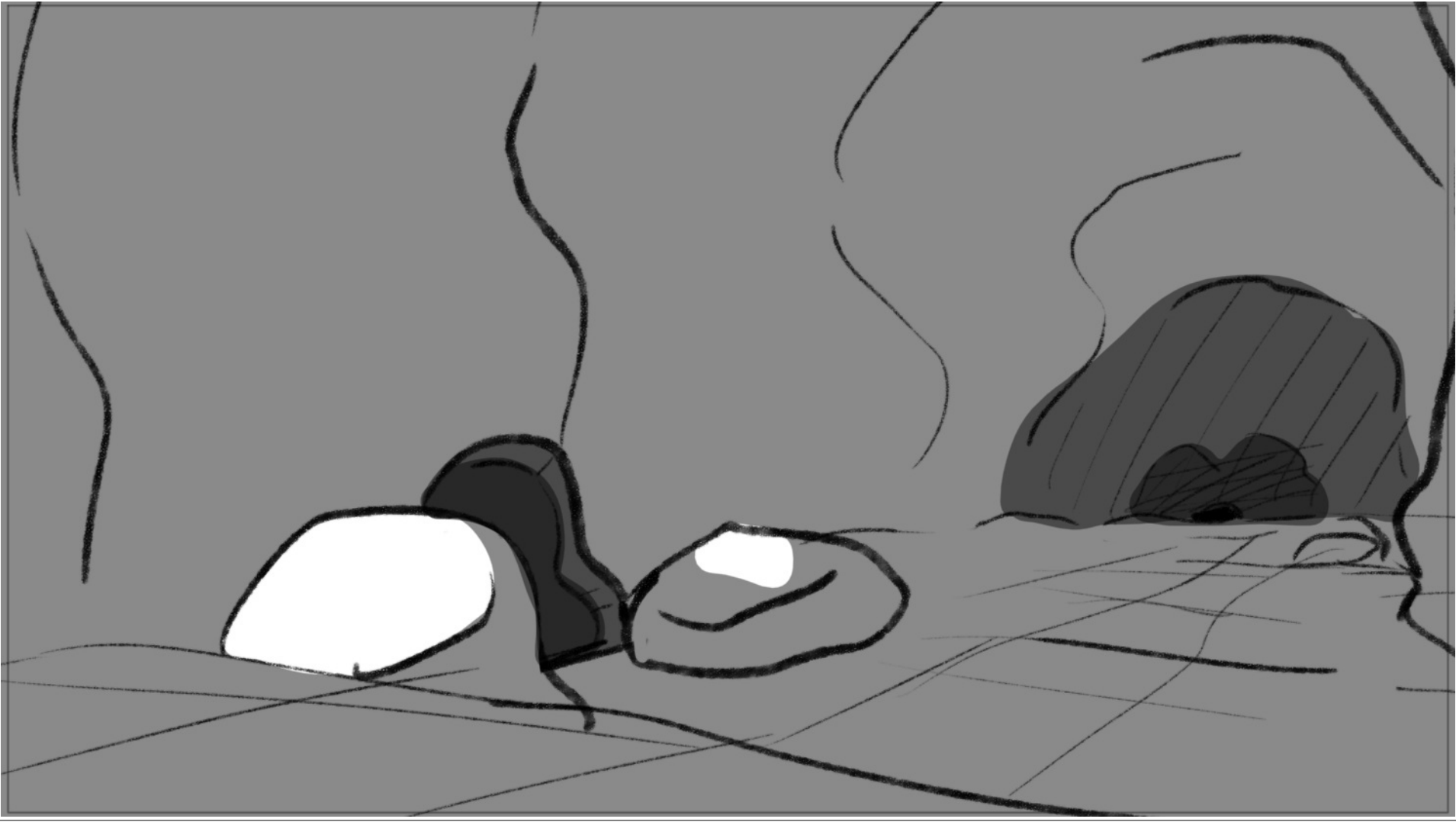

Scene	Panel
4	1

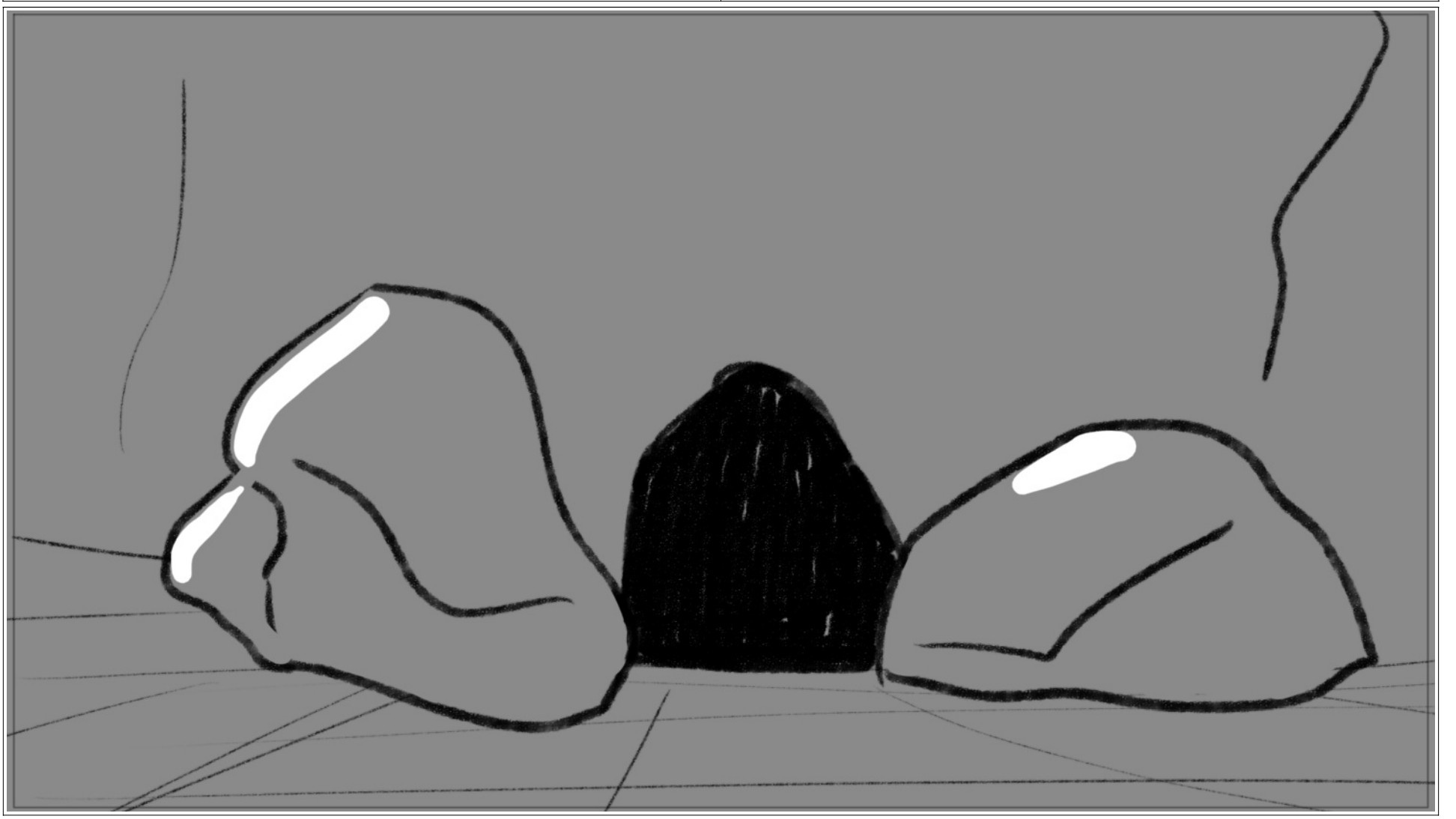

Scene	Panel
4	2



Scene	Panel
4	3



Scene	Panel
4	4

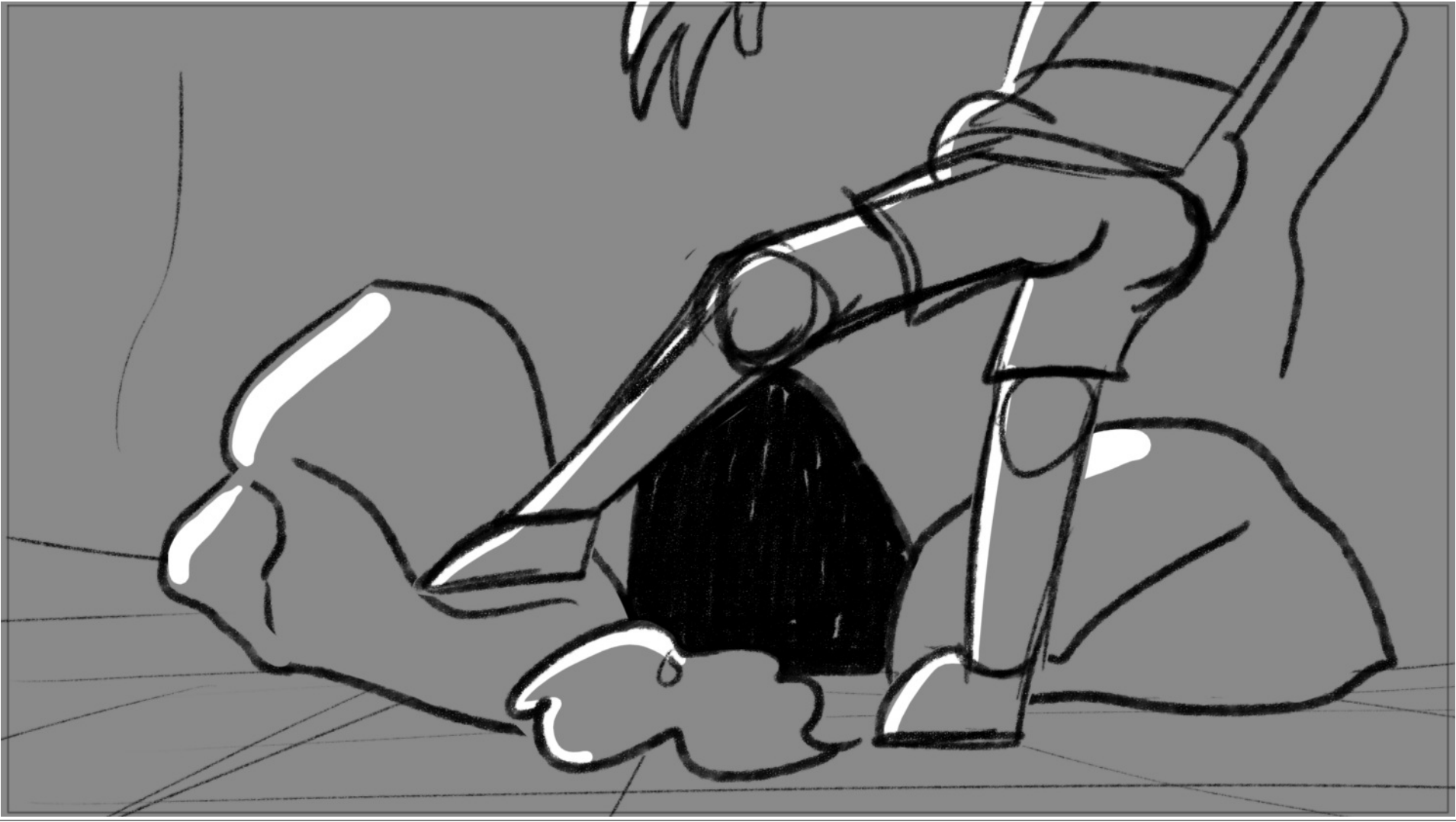

Scene	Panel
4	5



Scene	Panel
4	6



Scene	Panel
5	1

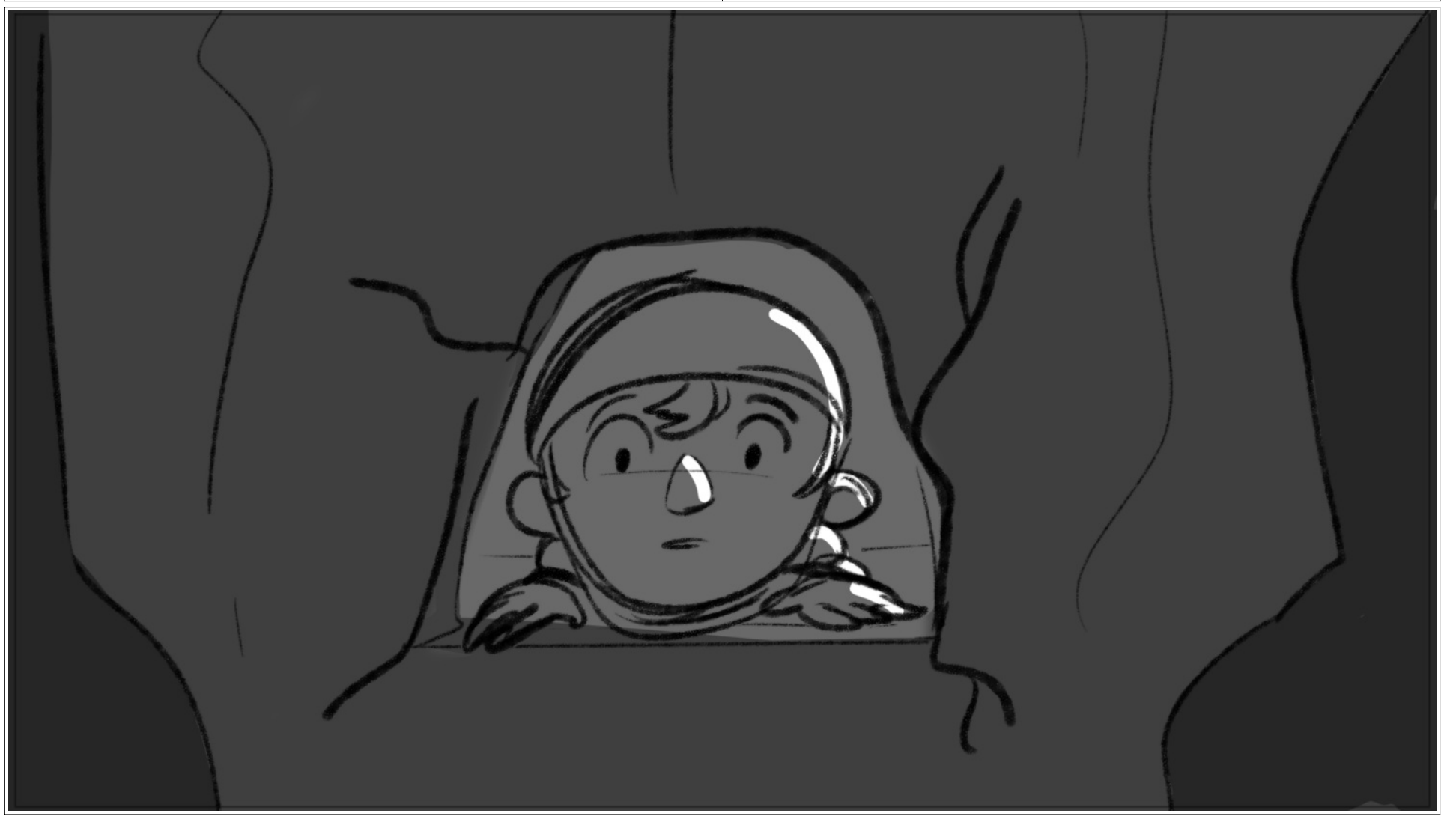

Scene	Panel
5	2



Scene	Panel
6	1

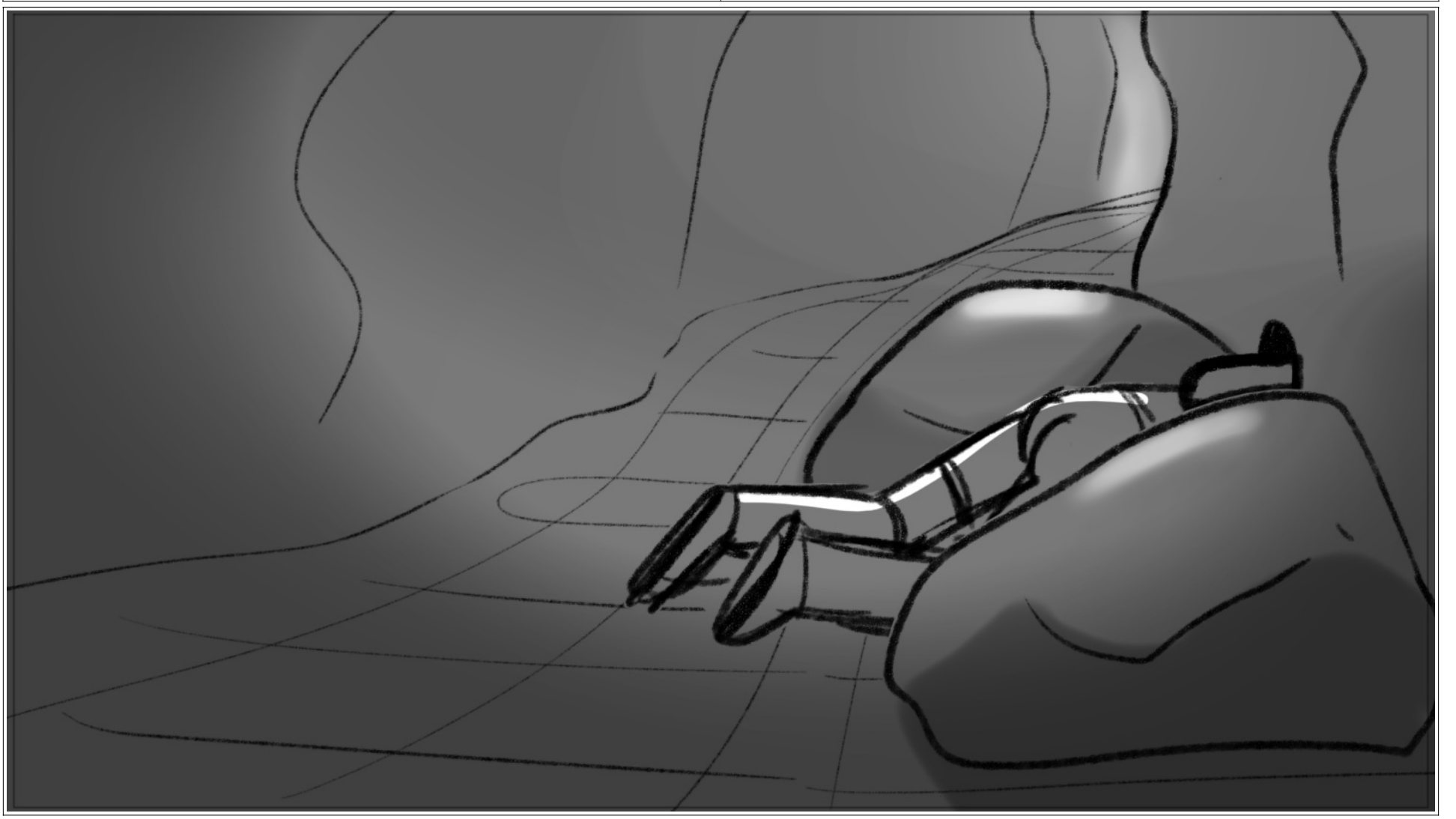

Scene	Panel
6	2

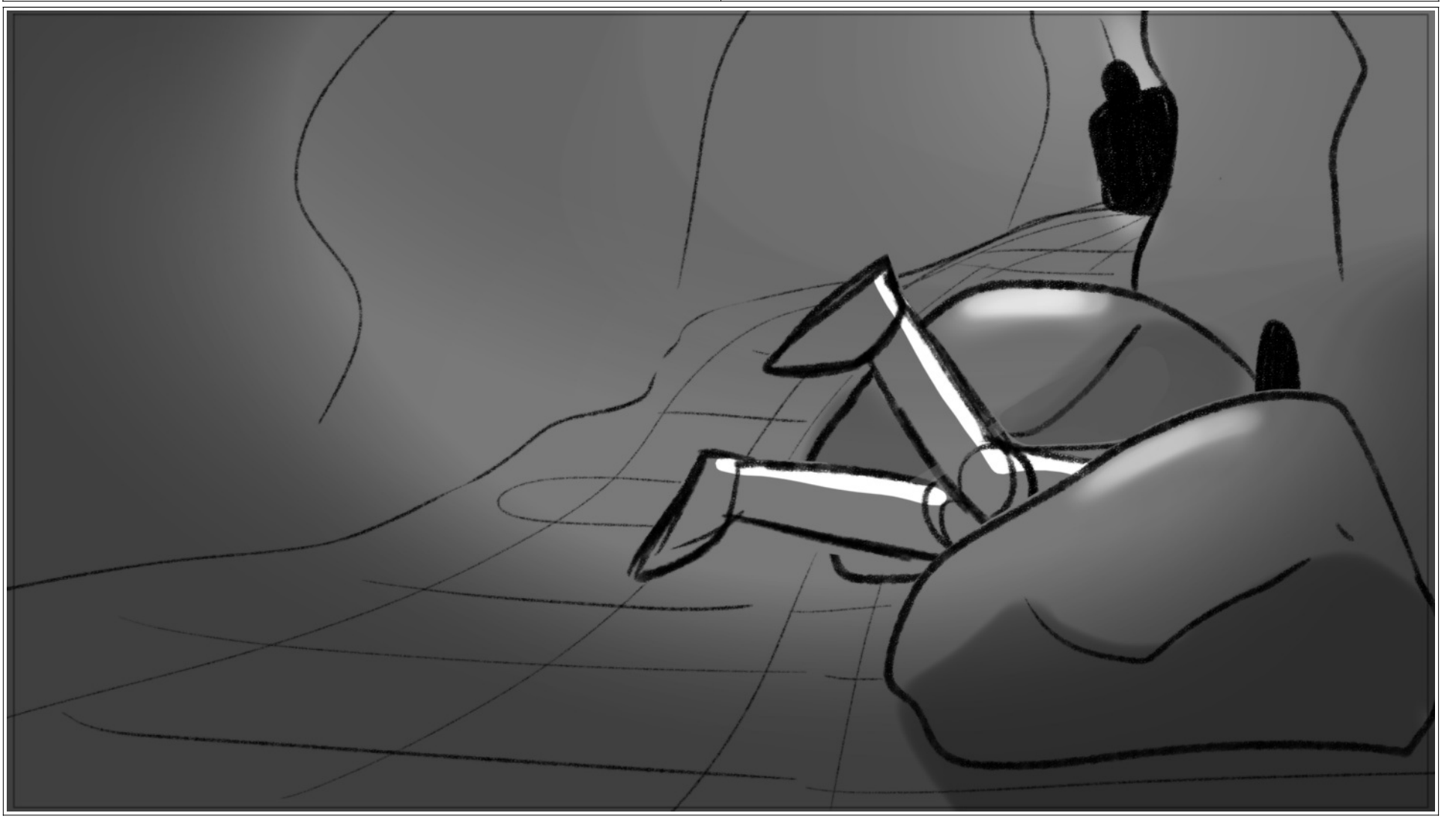

Scene	Panel
6	3

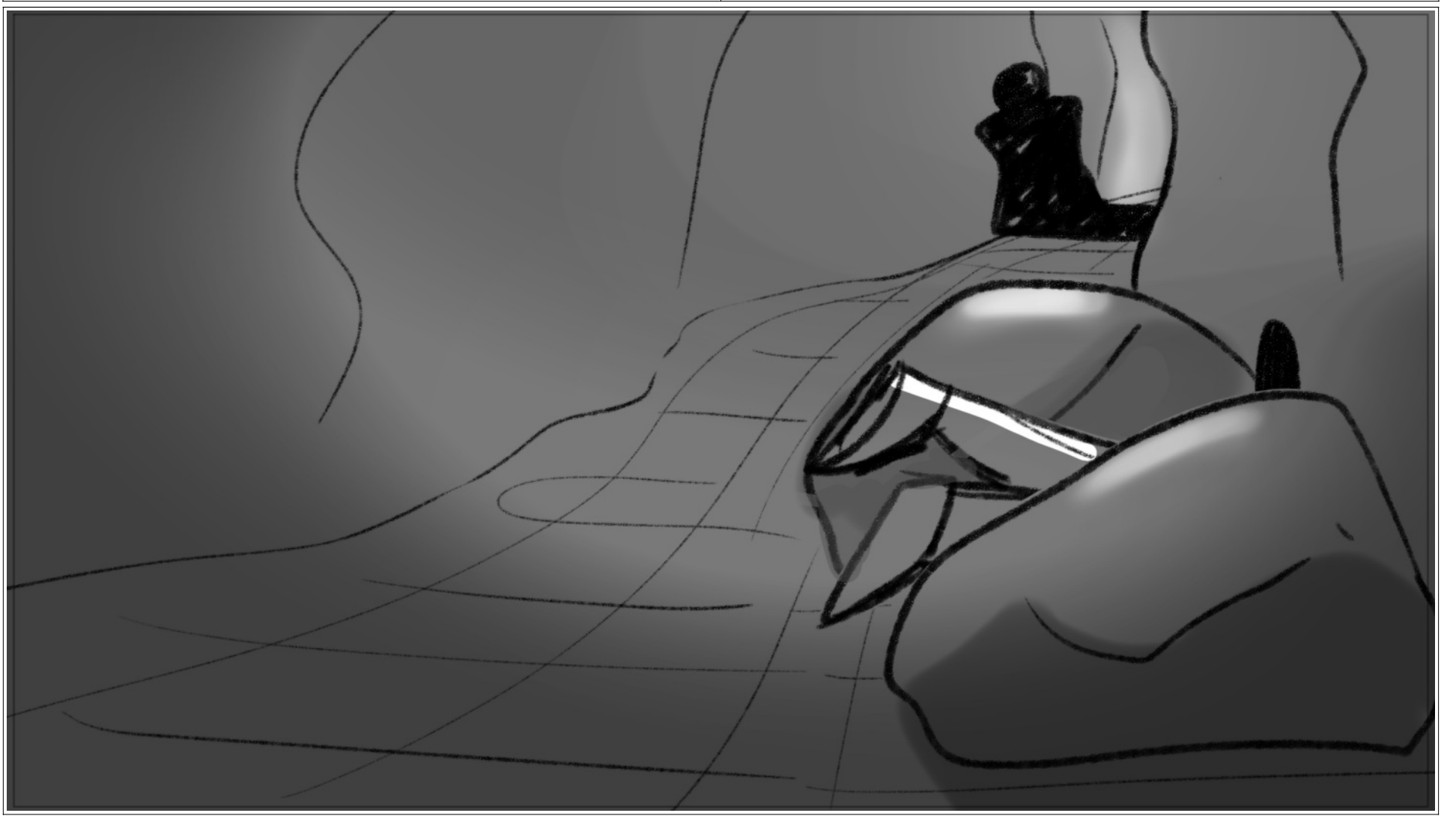

Scene	Panel
6	4

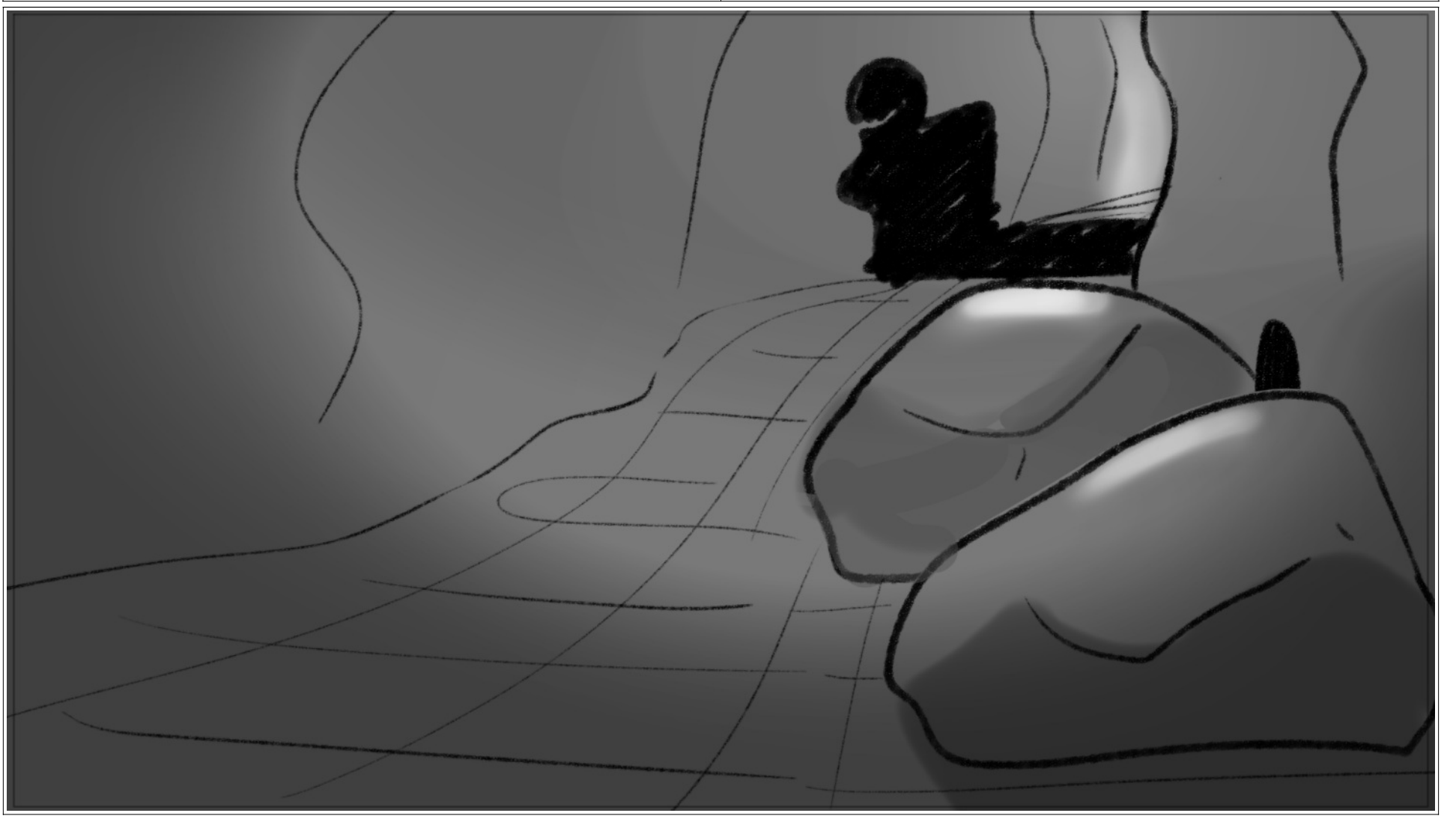

Scene	Panel
7	1



Dialog
SFX: (Loud Footsteps in the Distance)

Scene	Panel
7	2

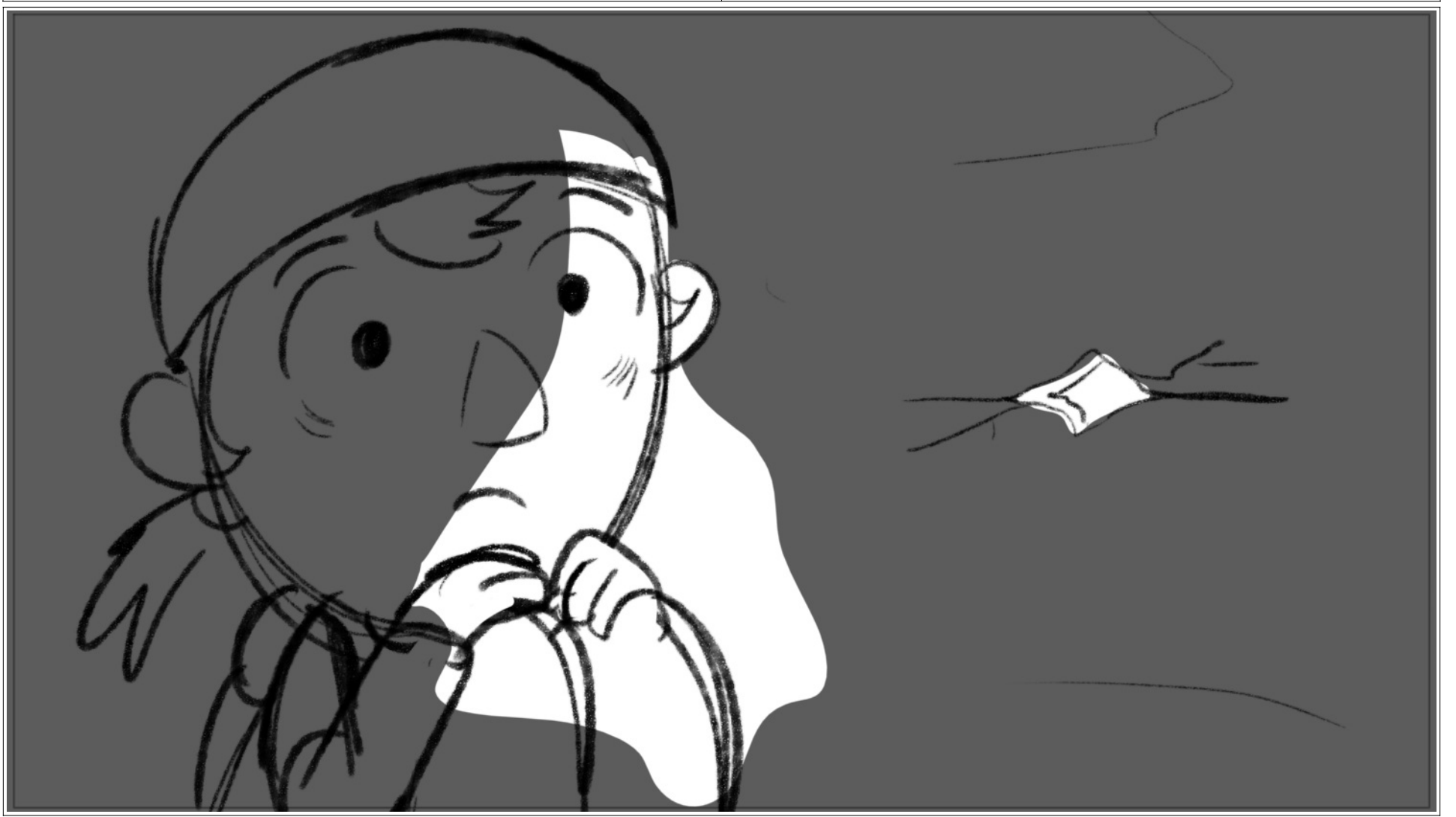

Dialog
SFX: (Loud Footsteps in the Distance)

Scene	Panel
7	3



Dialog
SFX: (Loud Footsteps in the Distance)

Scene	Panel
7	4



Dialog
SFX: (Loud Footsteps in the Distance)

Scene	Panel
7	5



Dialog
SFX: (Loud Footsteps in the Distance)

Scene	Panel
7	6



Dialog
SFX: (Loud Footsteps in the Distance)

Scene	Panel
7	7



Dialog
SFX: (Loud Footsteps in the Distance)

Scene	Panel
7	8

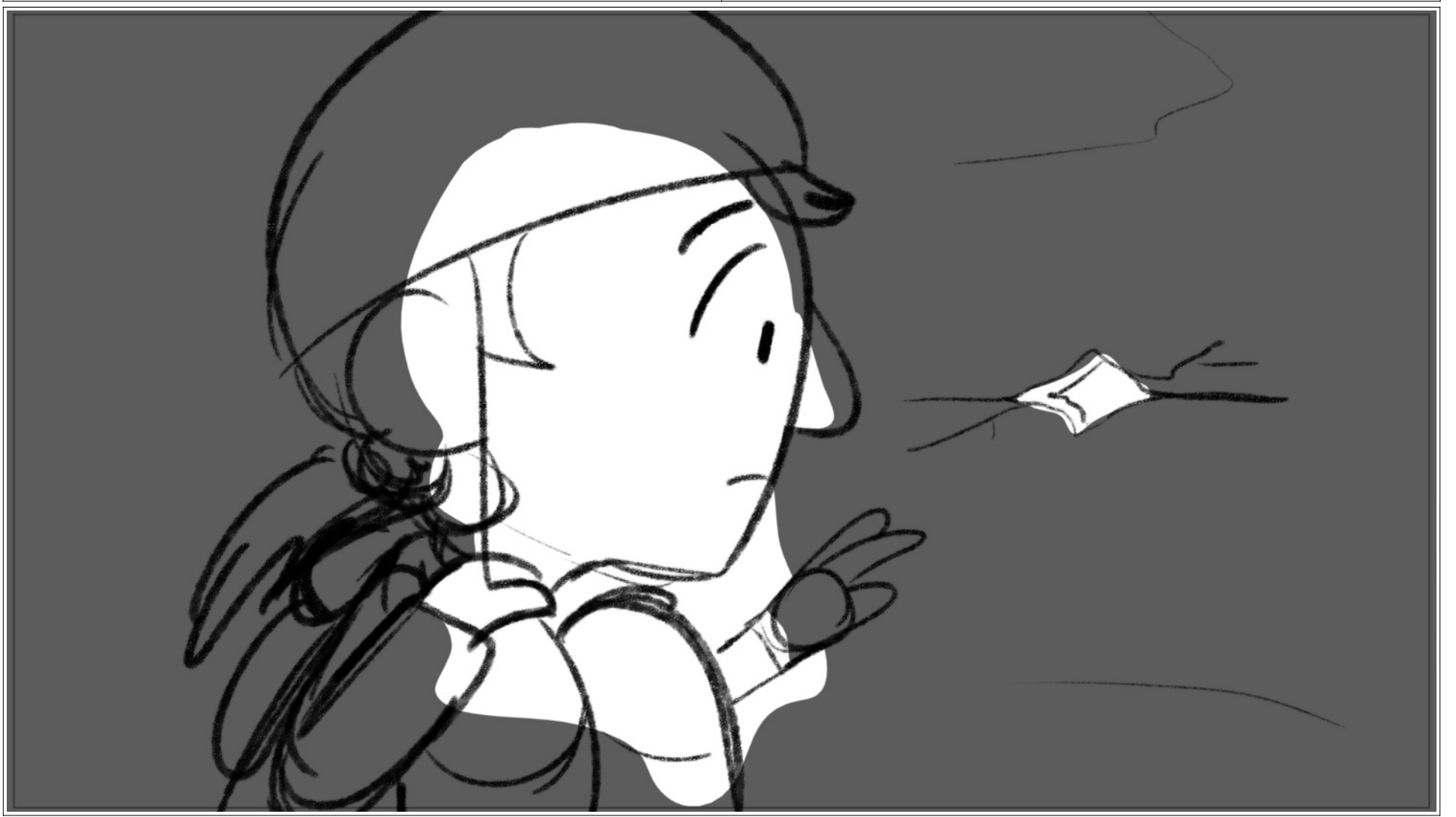

Dialog
SFX: (Loud Footsteps in the Distance)

Scene	Panel
8	1

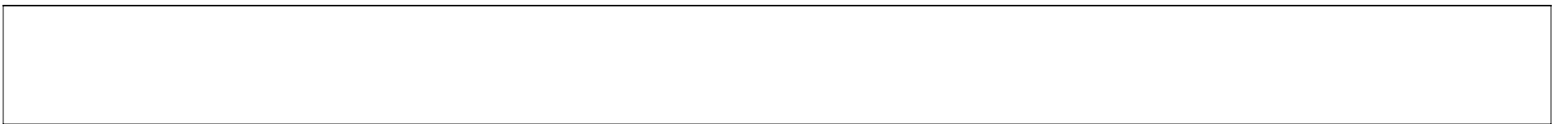
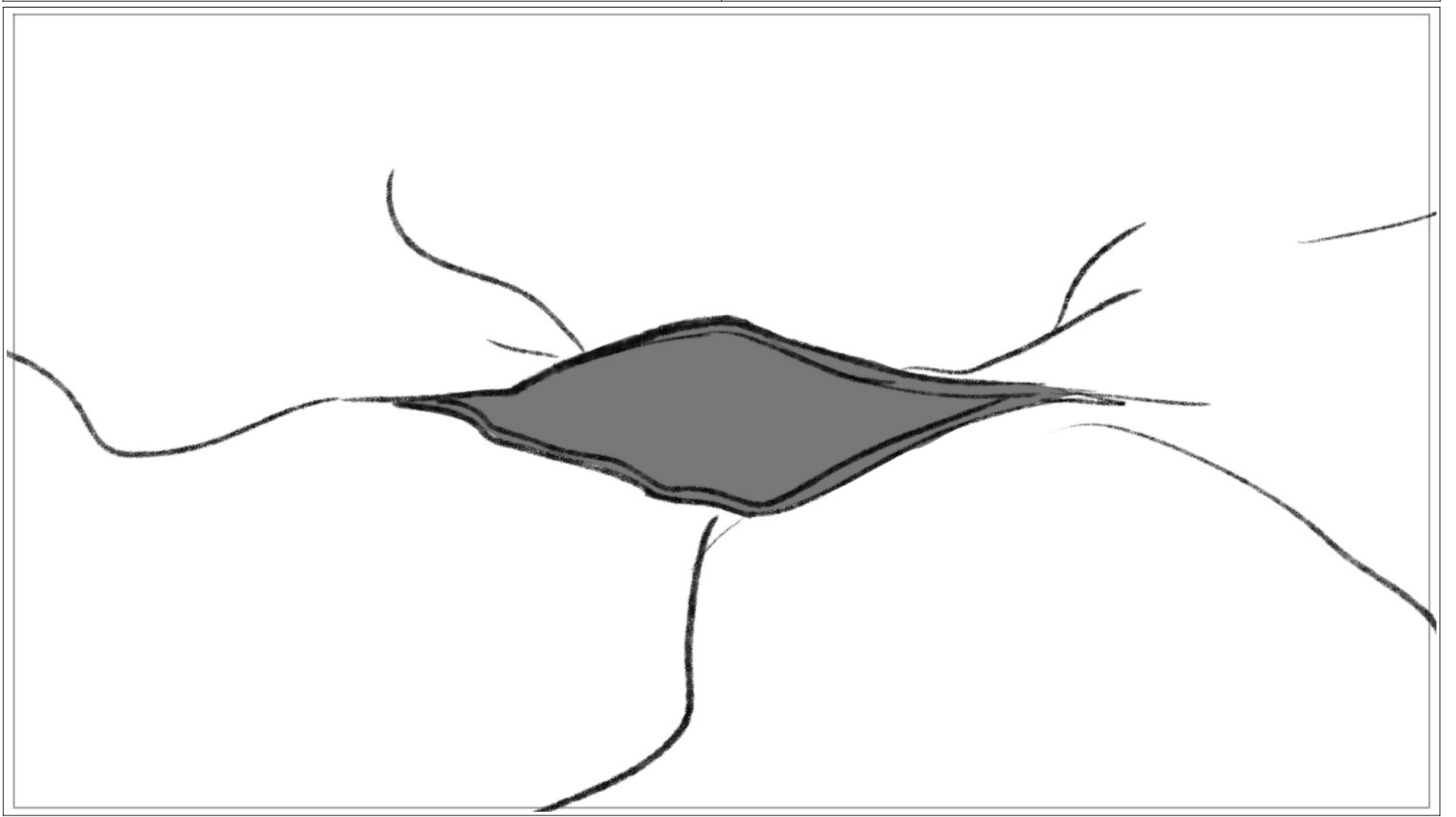

Scene	Panel
8	2

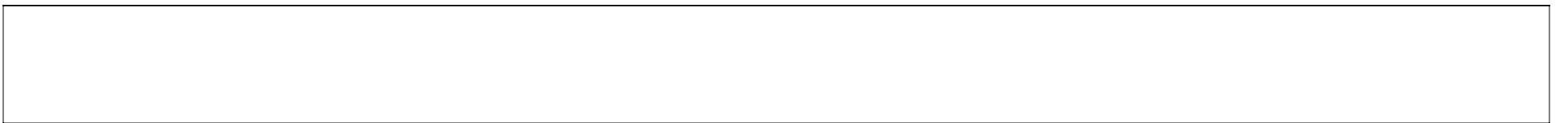
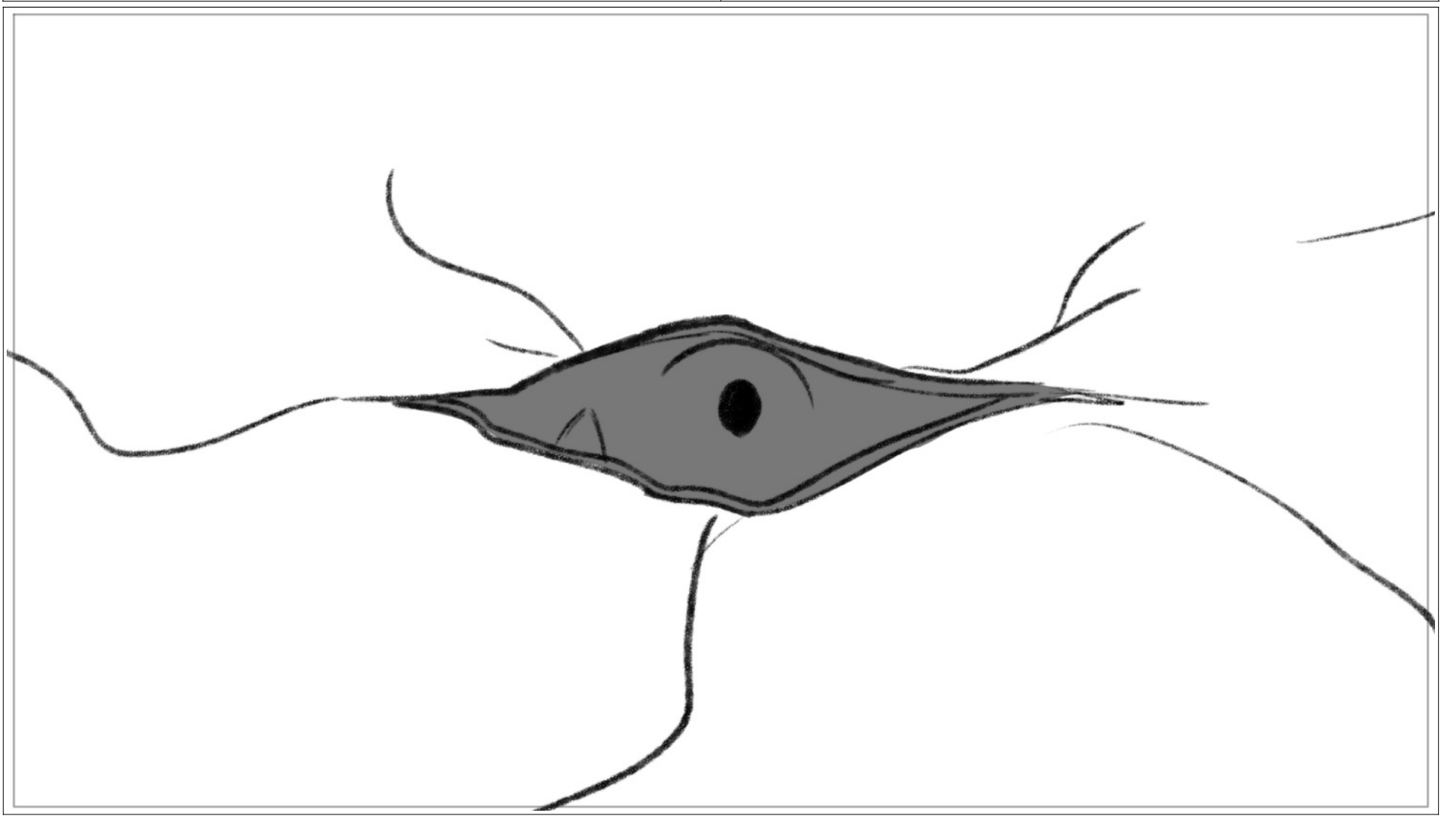

Scene	Panel
8	3

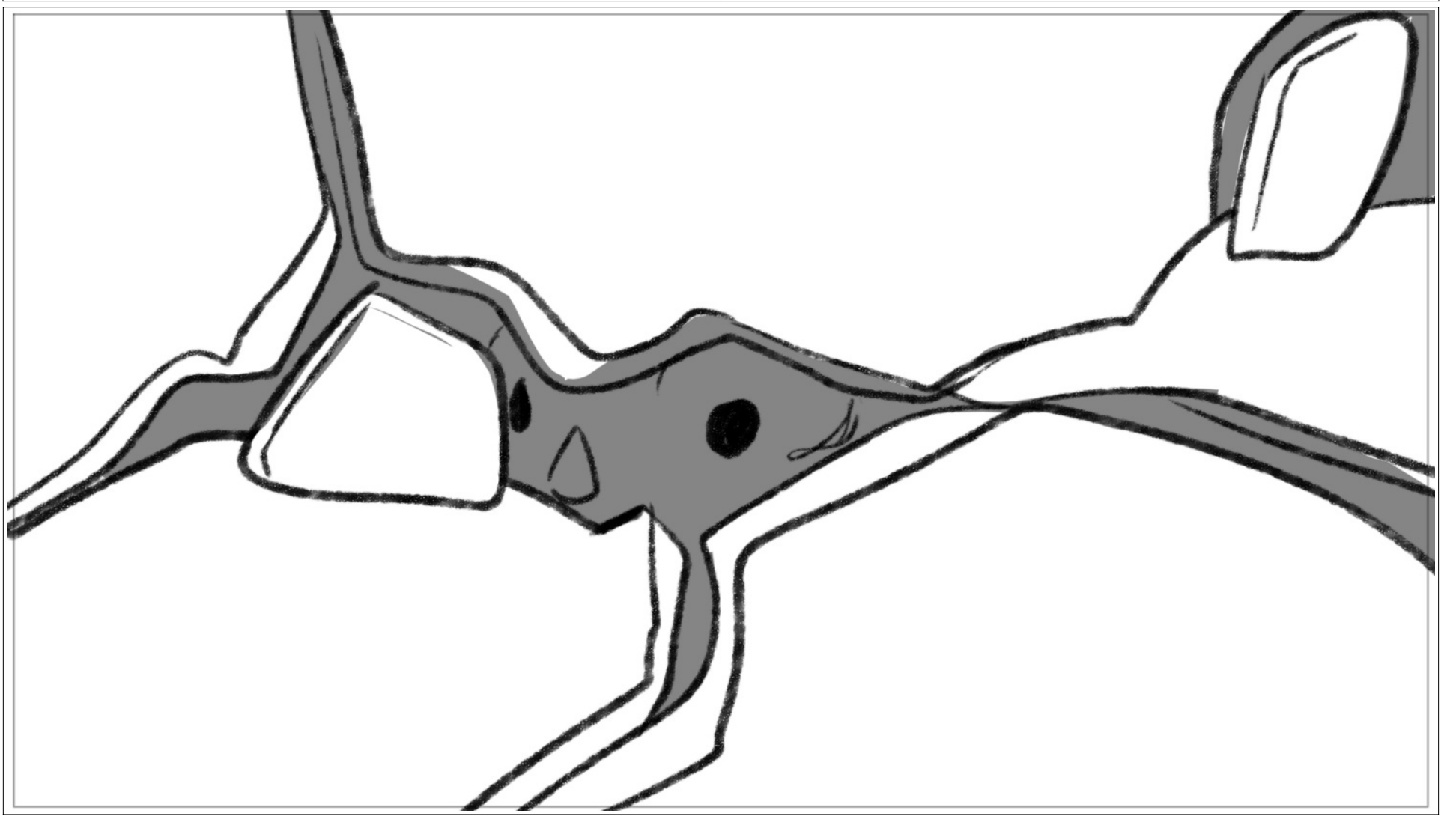

Scene	Panel
8	4

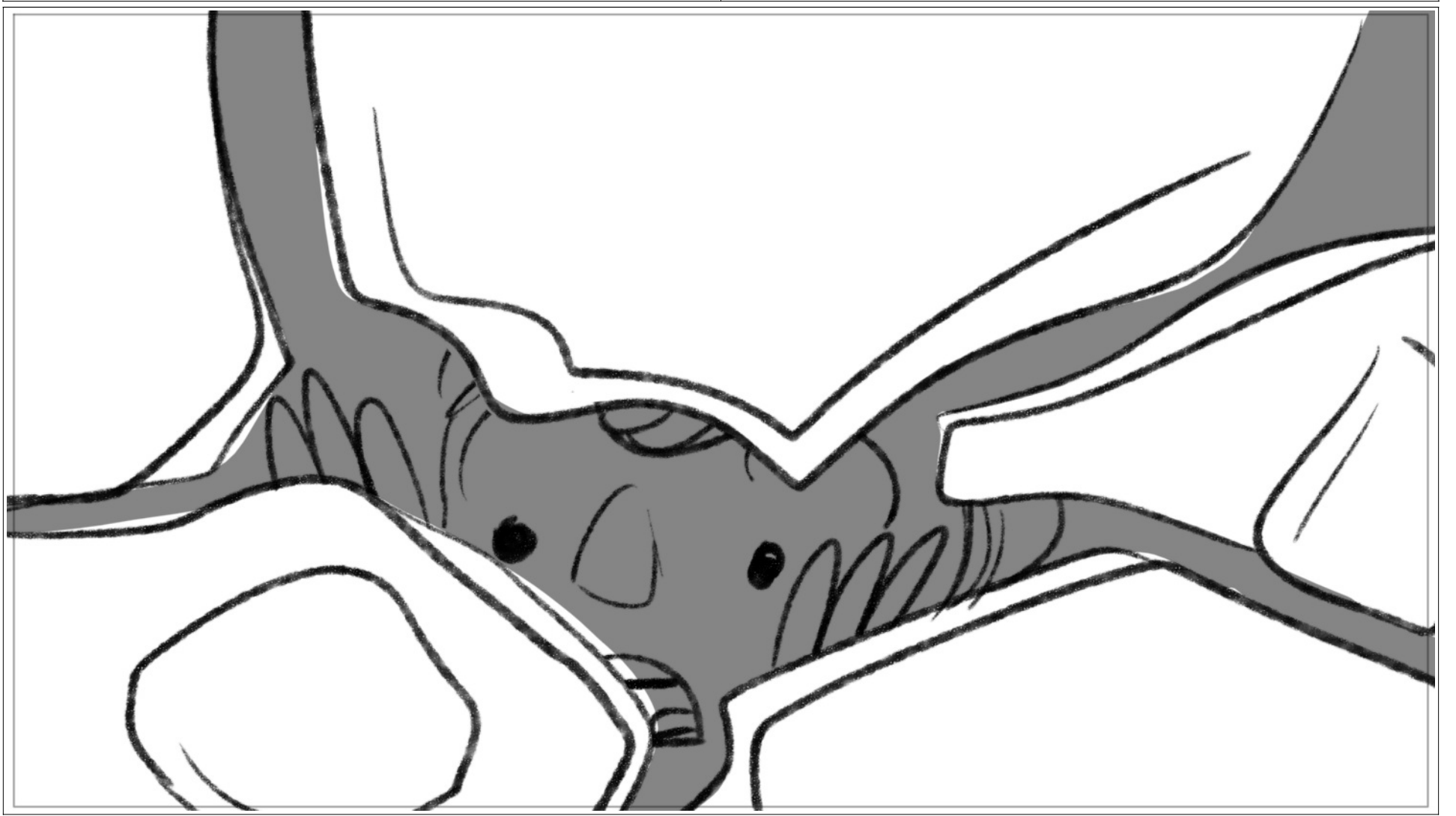

Scene	Panel
9	1



Scene	Panel
9	2



Scene	Panel
9	3

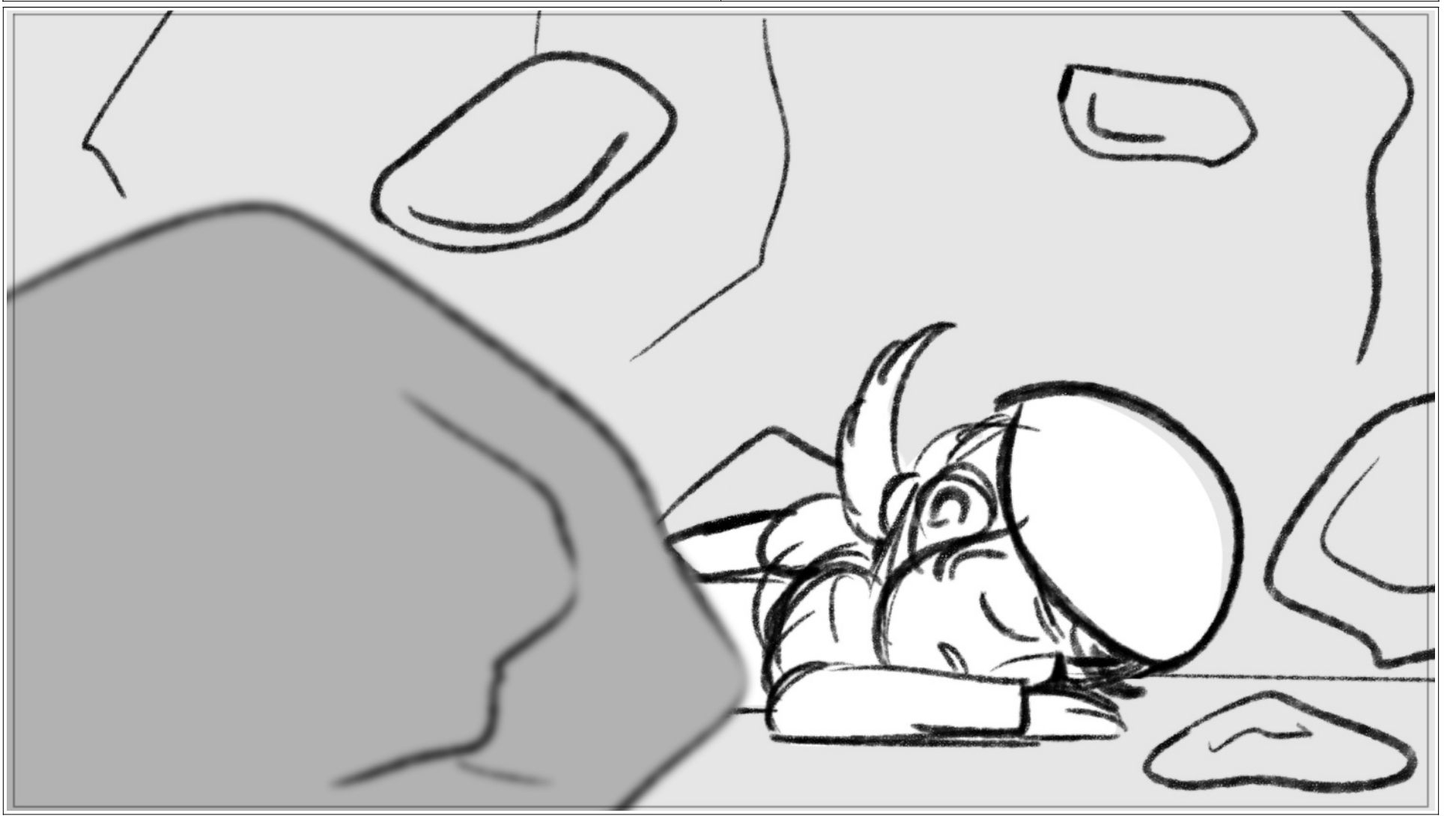

Scene	Panel
9	4

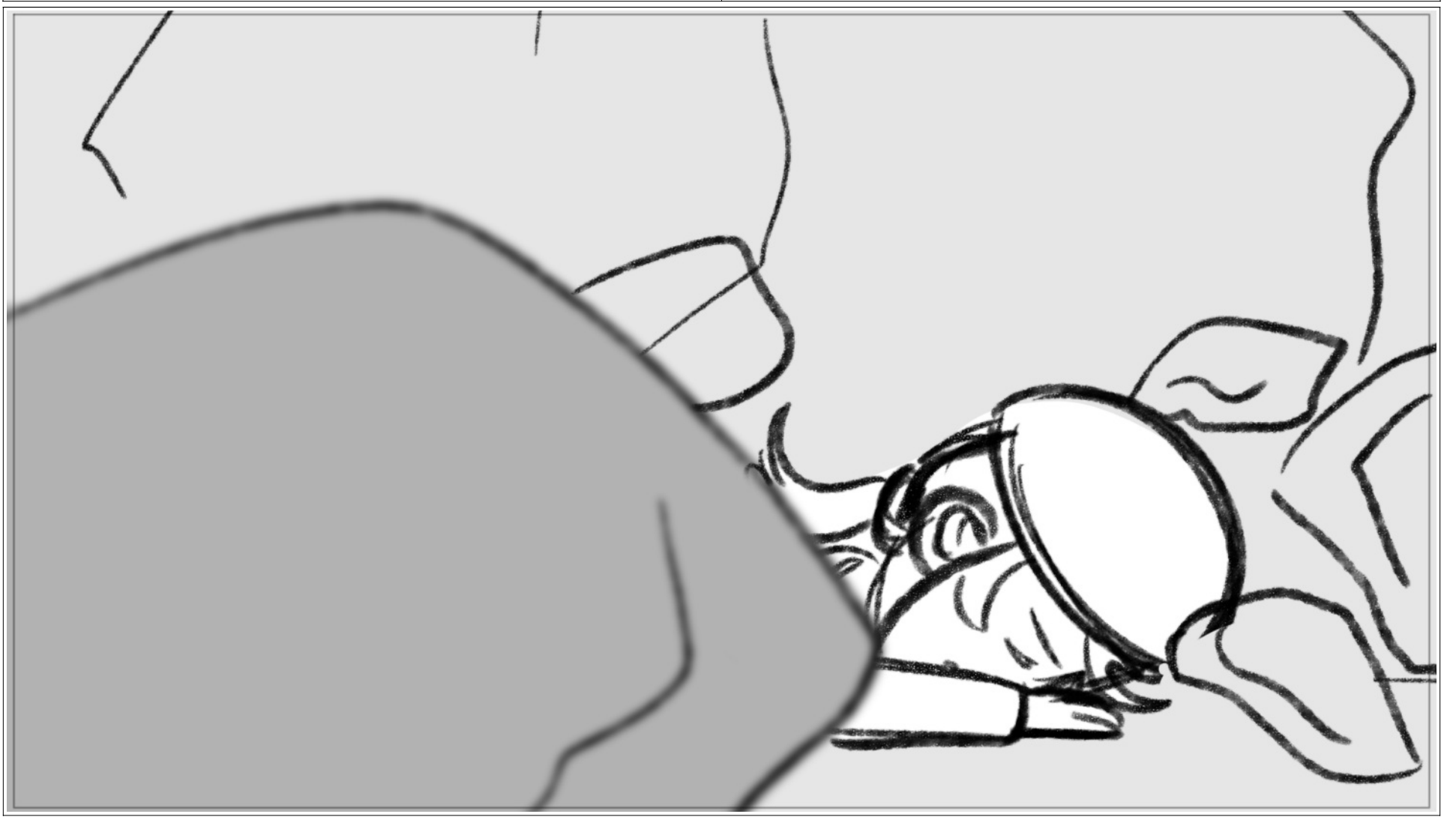

Scene	Panel
9	5



Scene	Panel
9	6



Scene	Panel
9	7



Scene 10	Panel 1
-------------	------------



Scene 10	Panel 2
-------------	------------

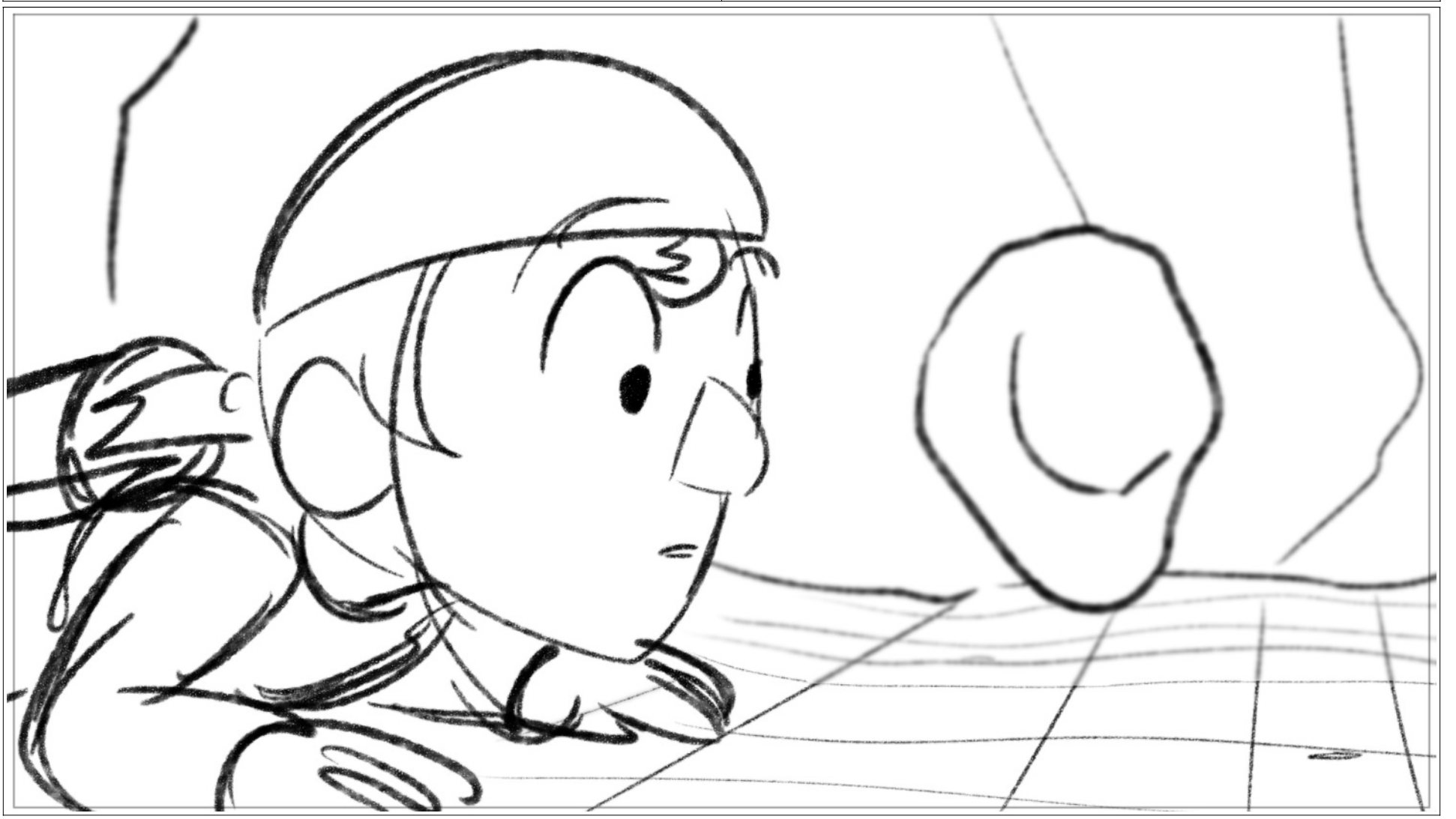

Scene	Panel
10	3

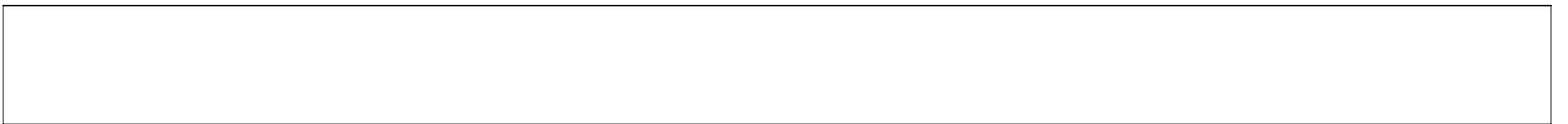
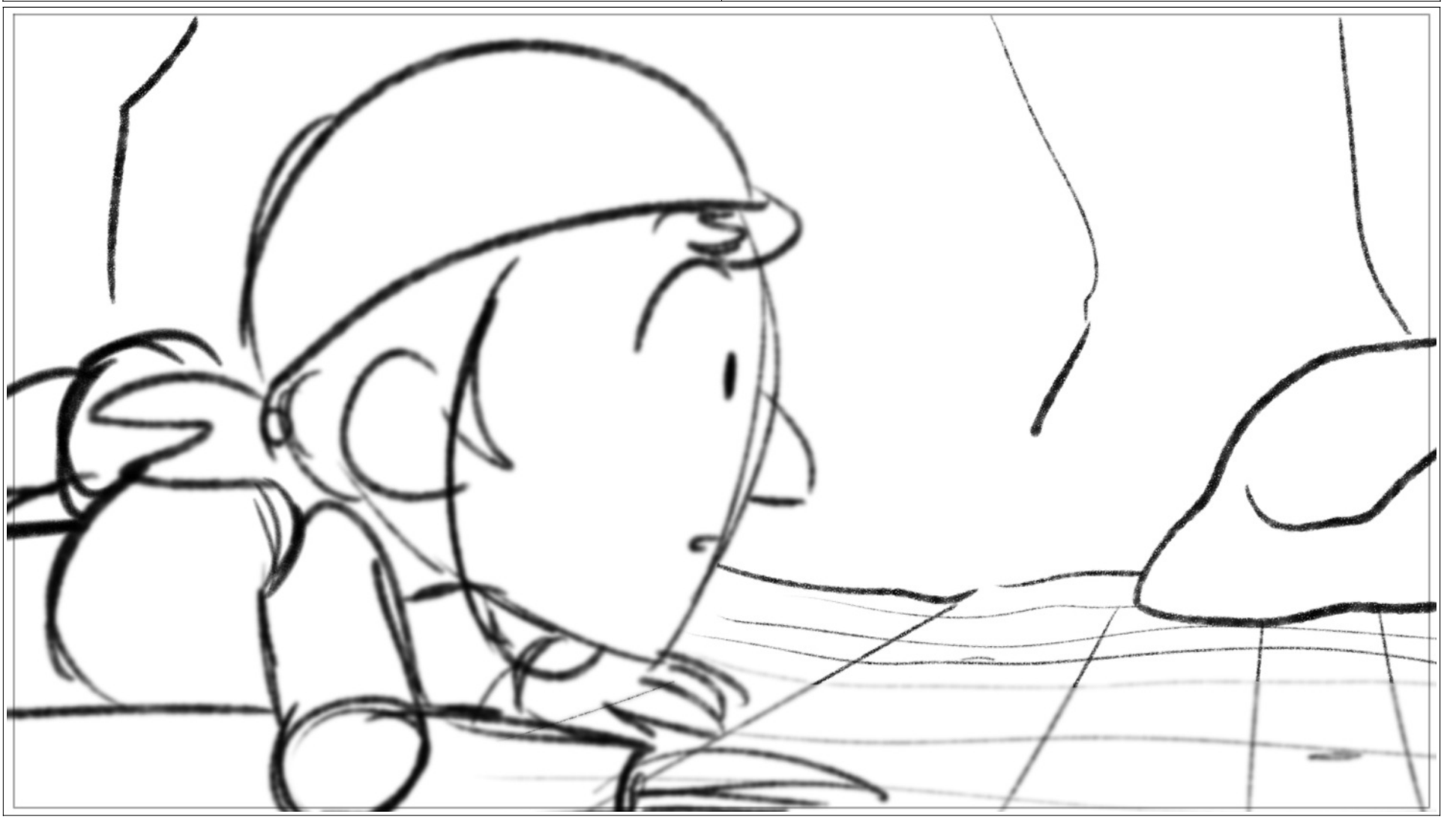

Scene	Panel
10	4

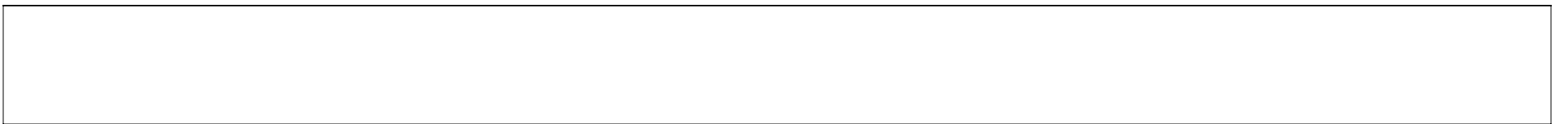
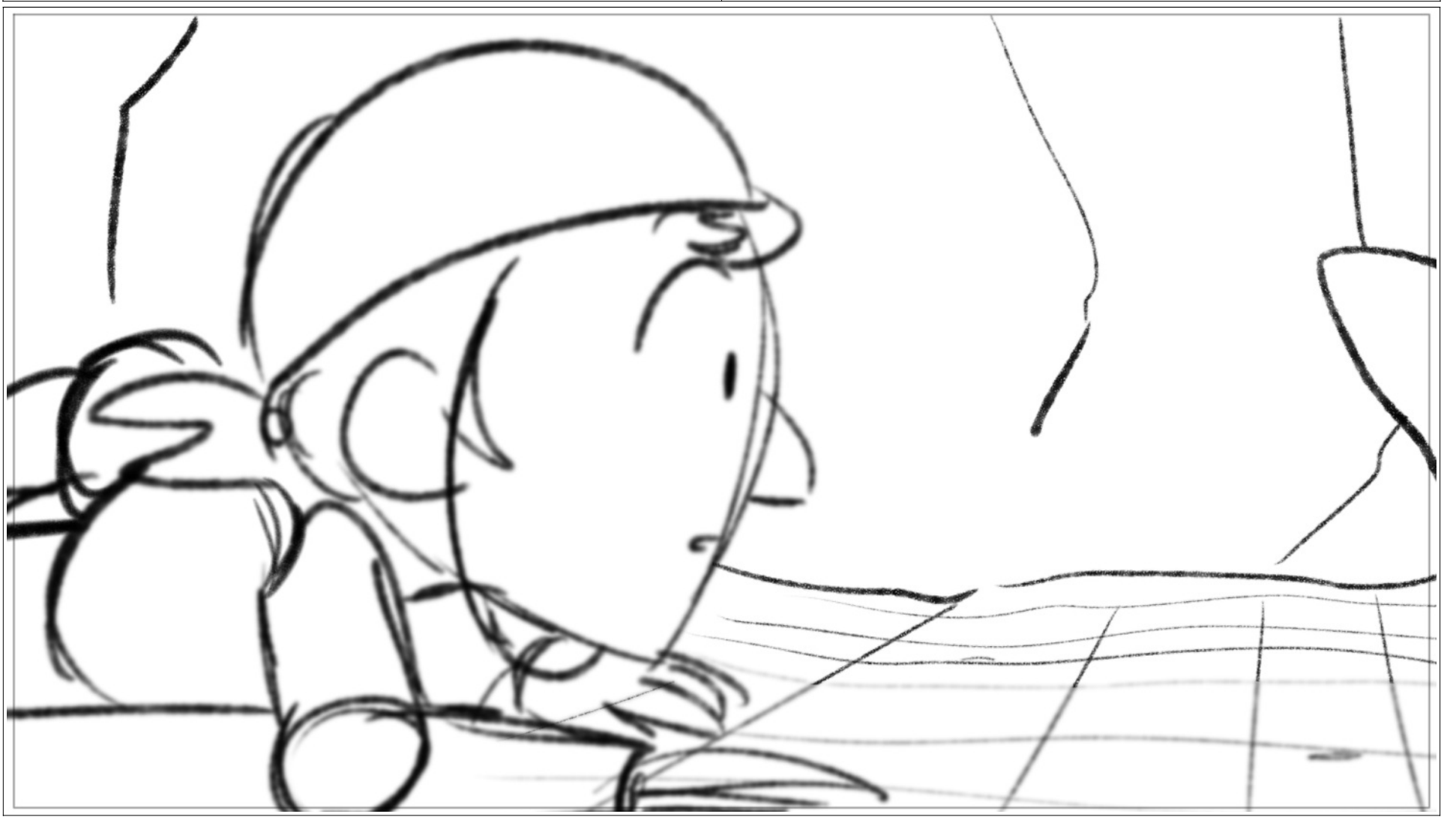

Scene	Panel
11	1

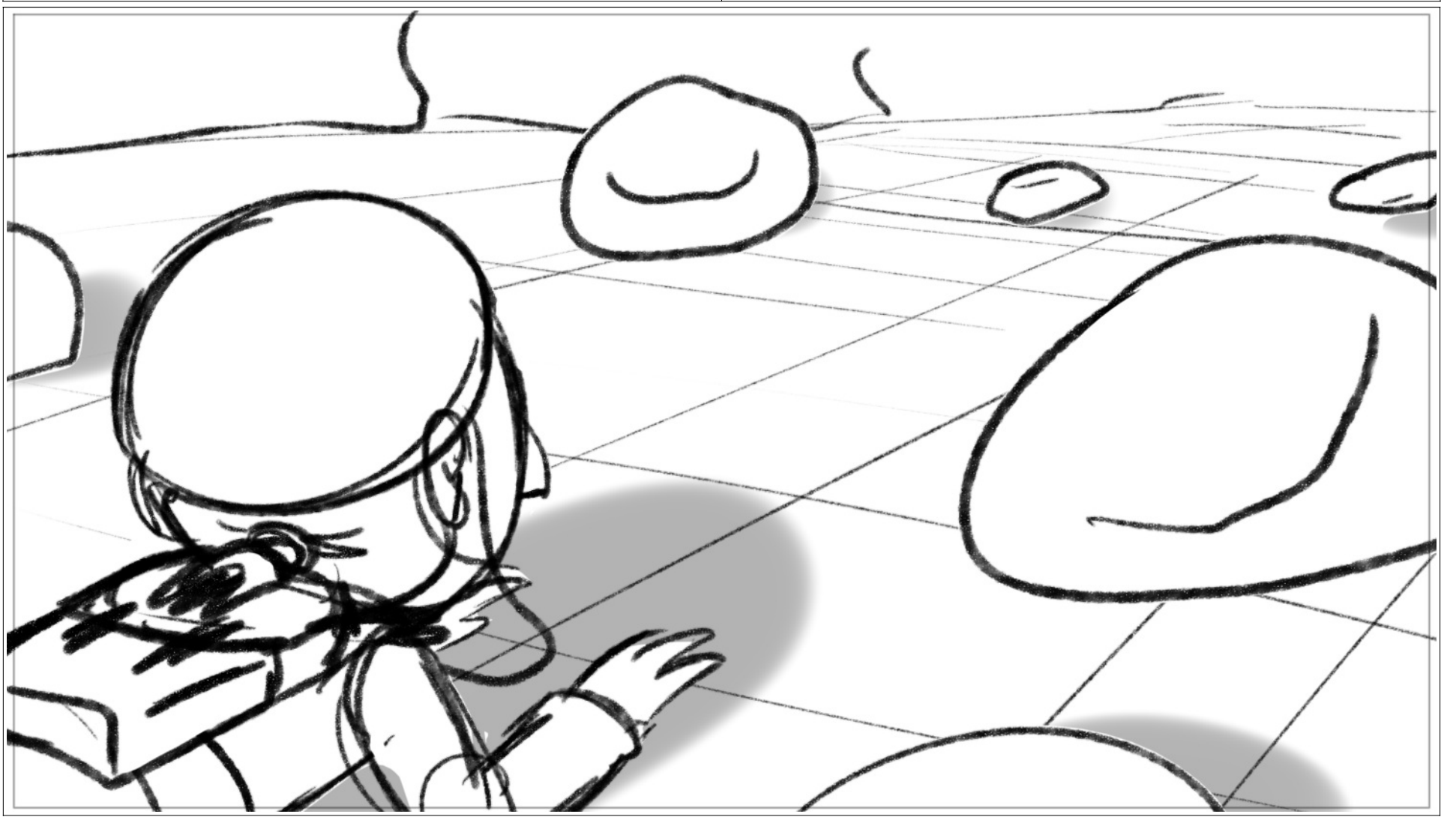

Scene	Panel
11	2

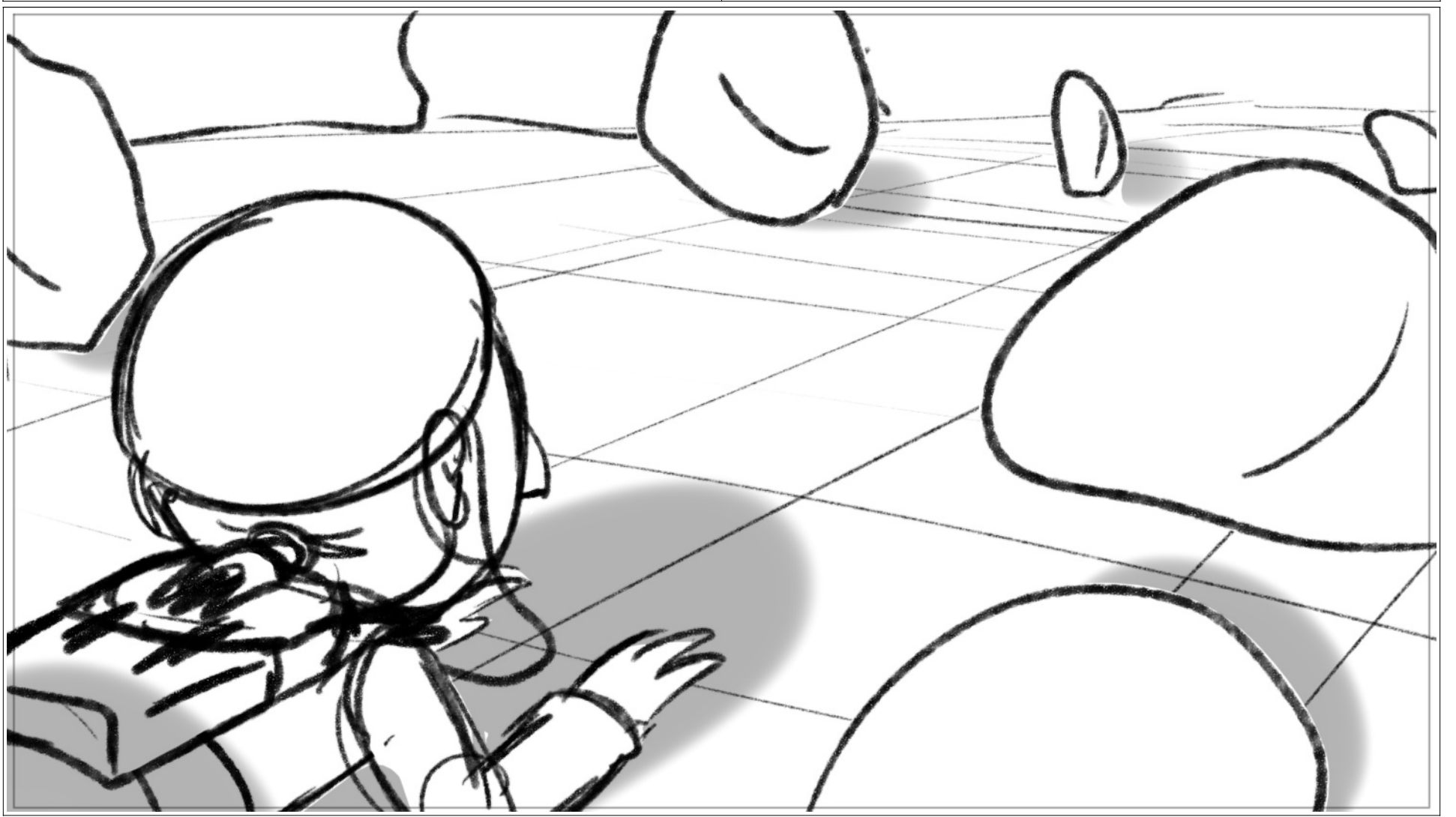

Scene	Panel
11	3

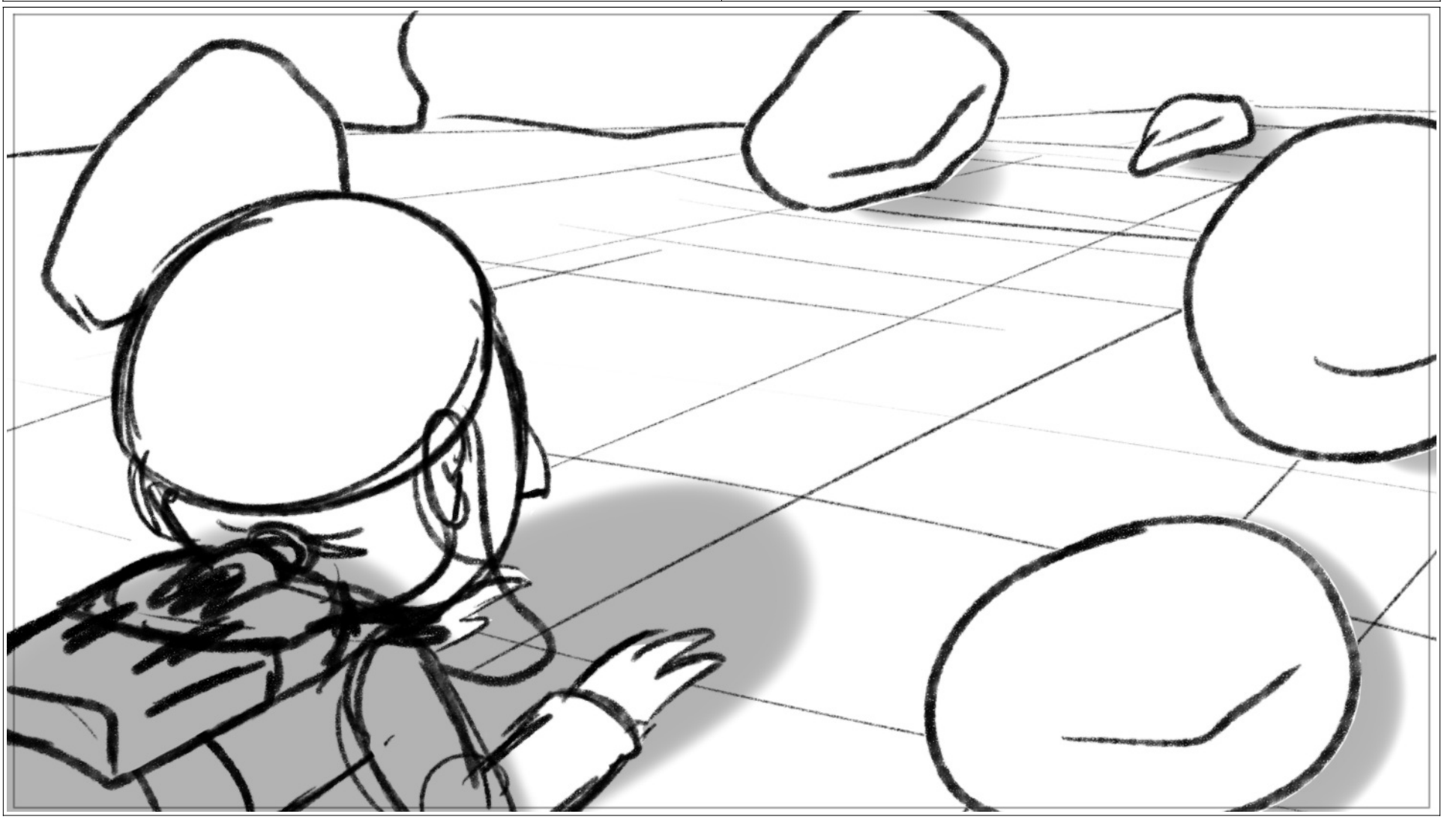

Scene	Panel
11	4



Scene 11	Panel 5
-------------	------------

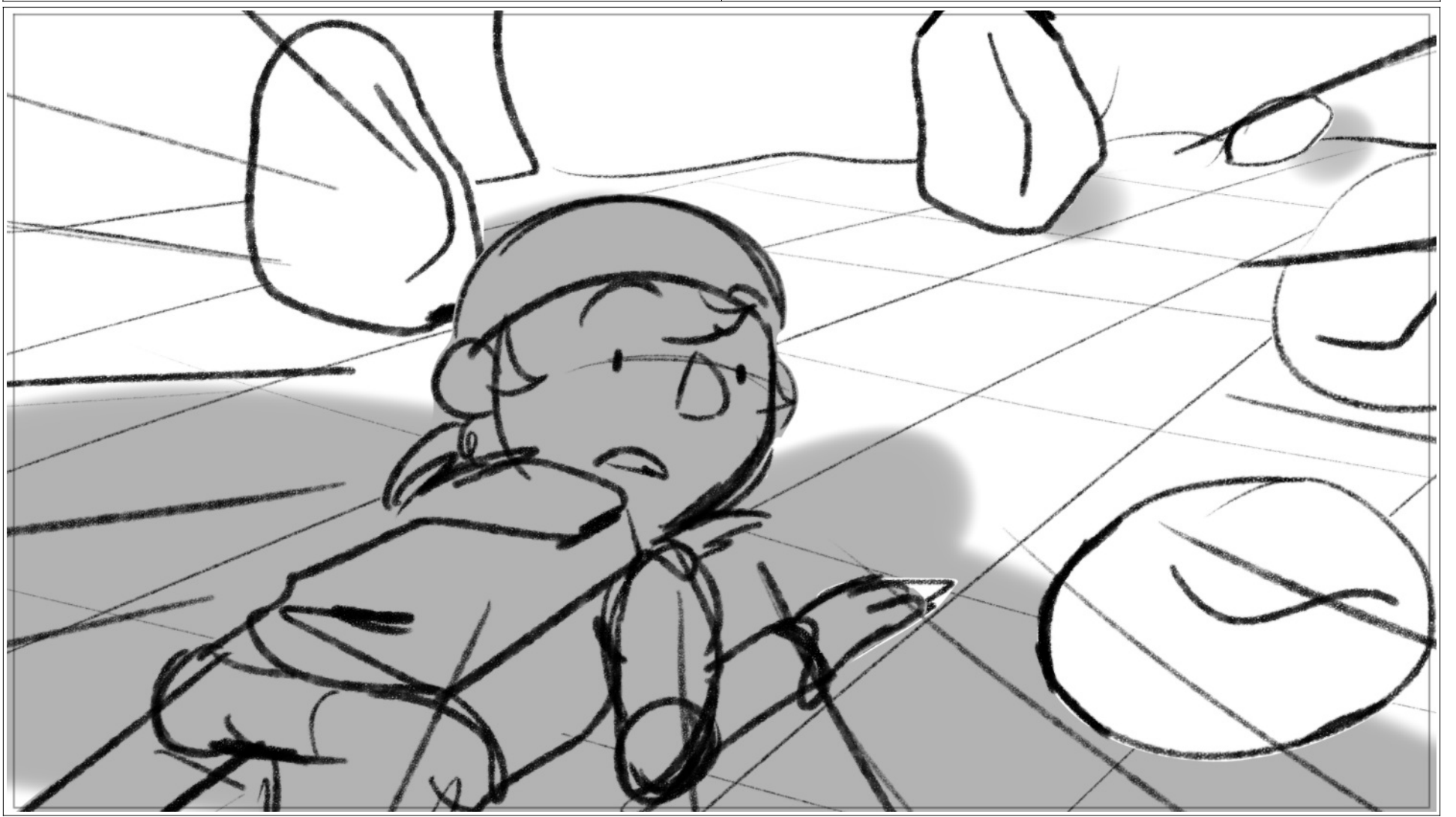

Scene	Panel
11	6

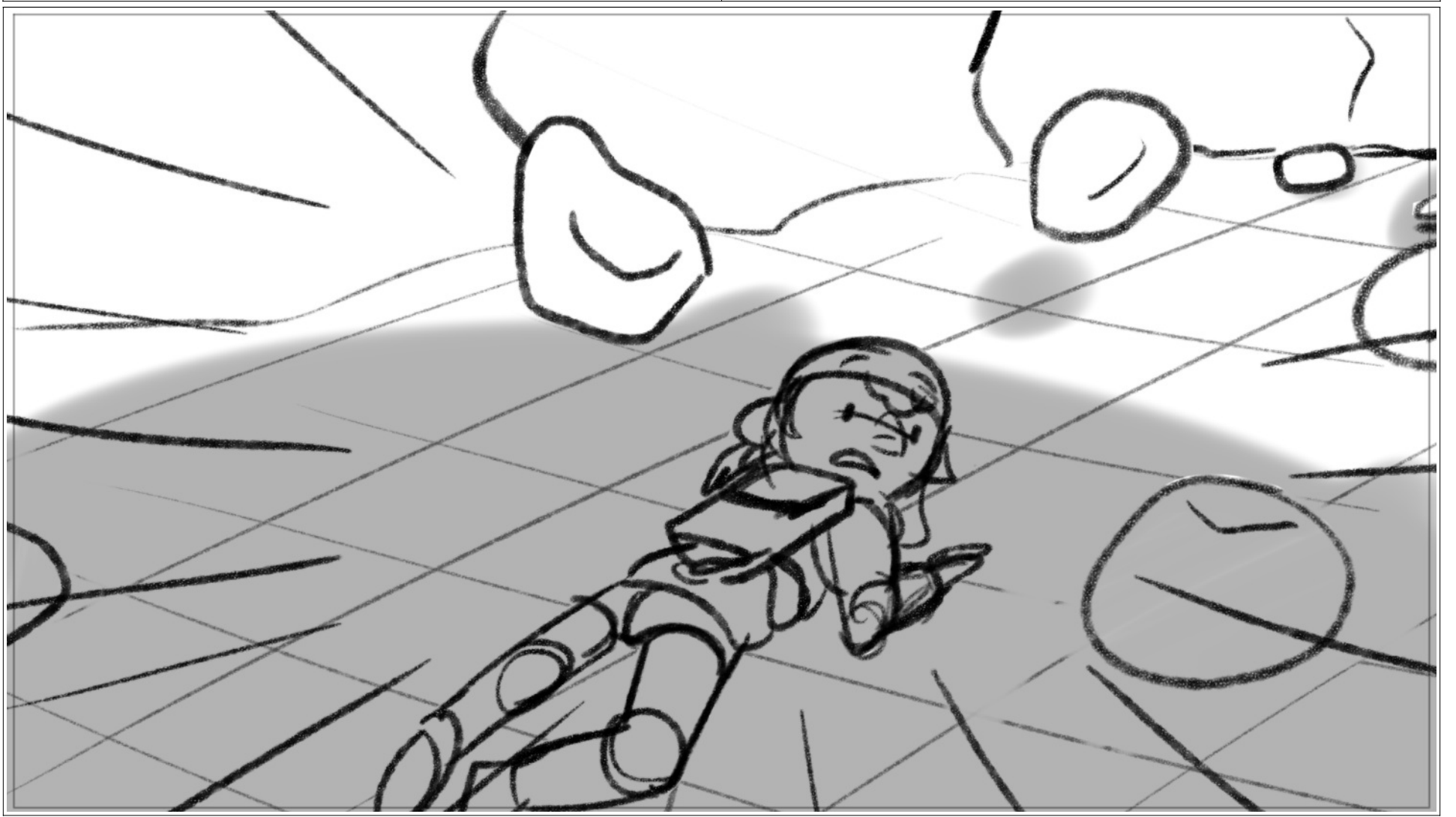

Scene	Panel
11	7

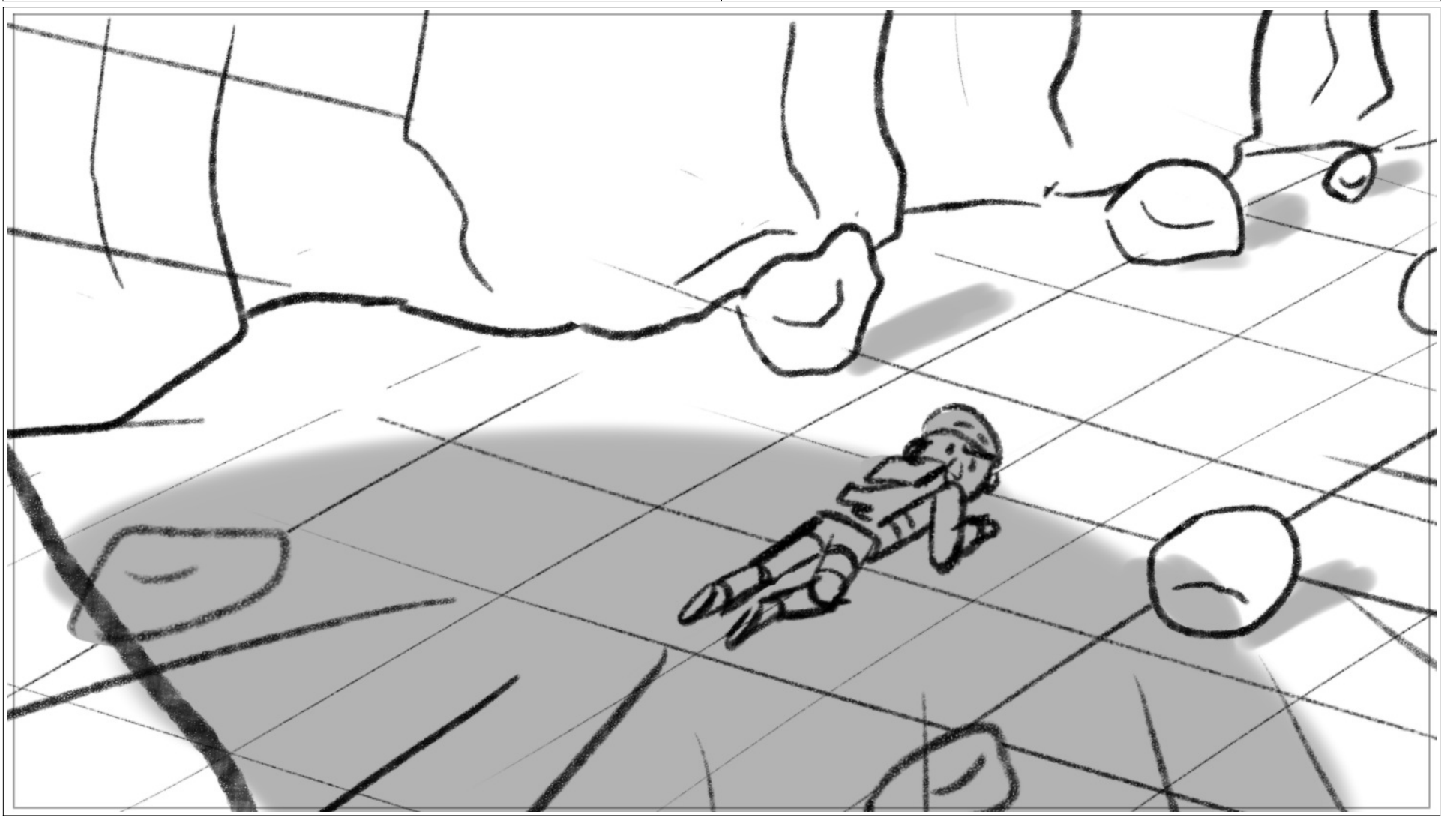

Scene	Panel
11	8

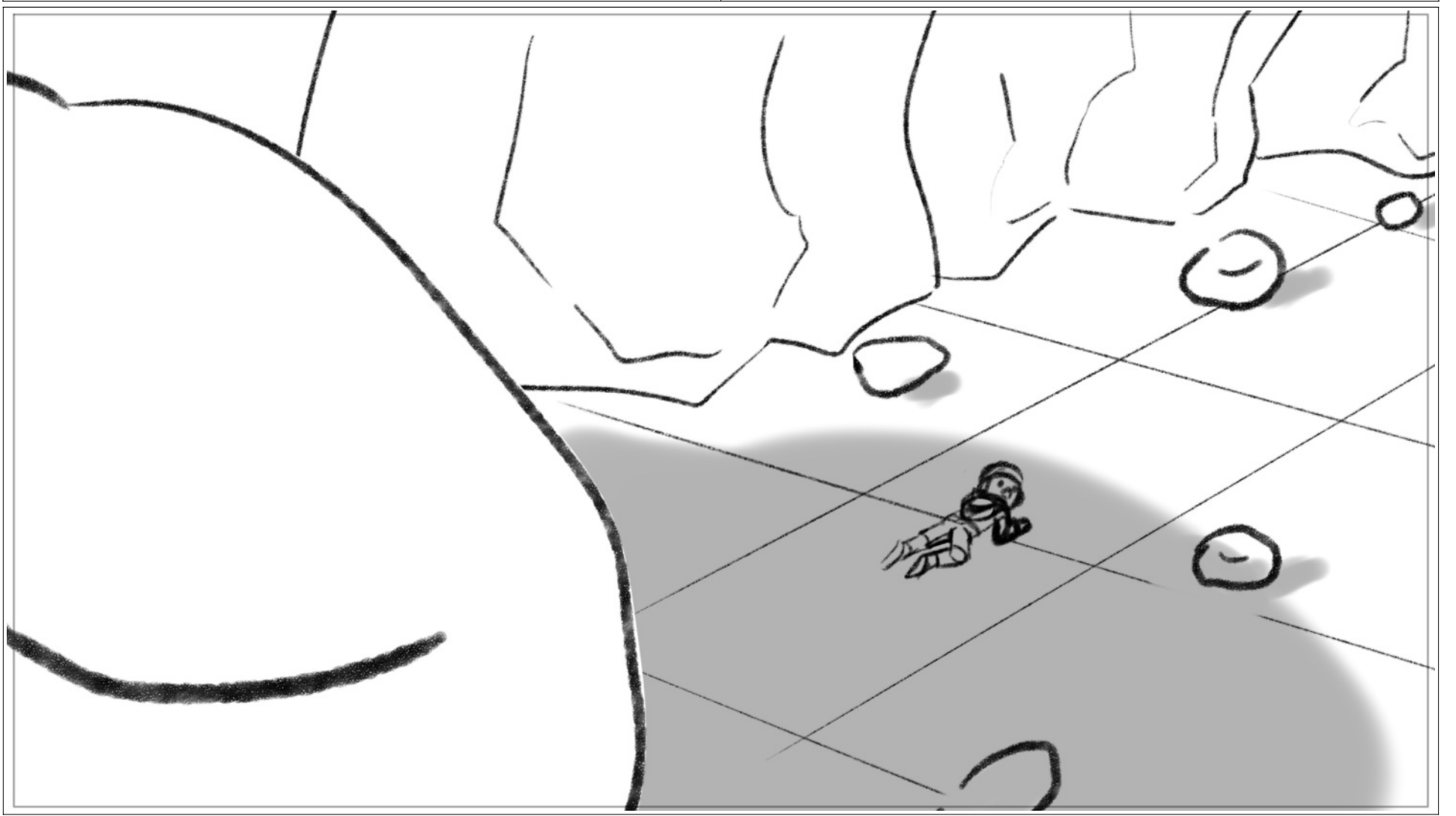

Scene 12	Panel 1
-------------	------------



Scene	Panel
12	2

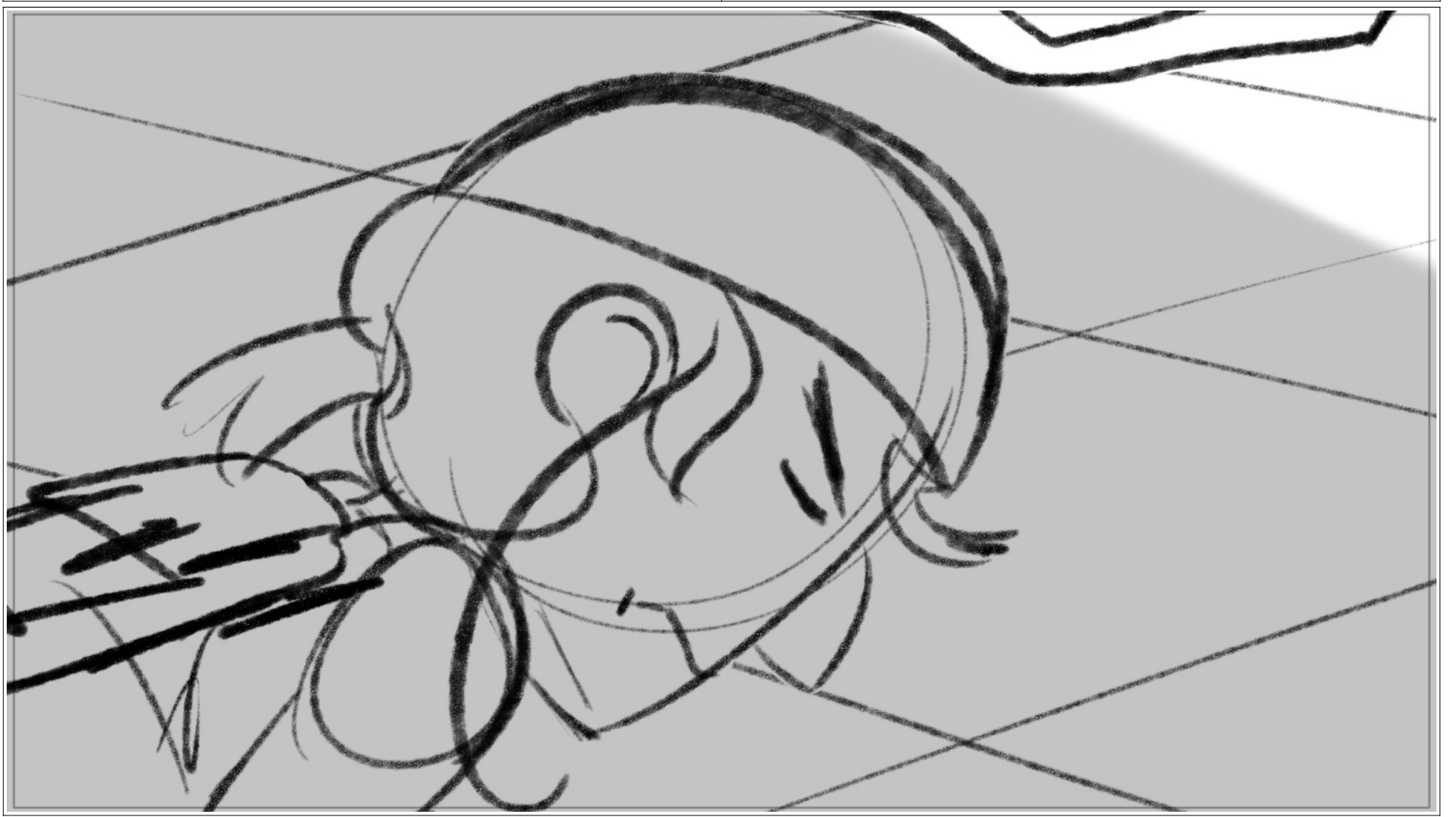

Scene	Panel
12	3

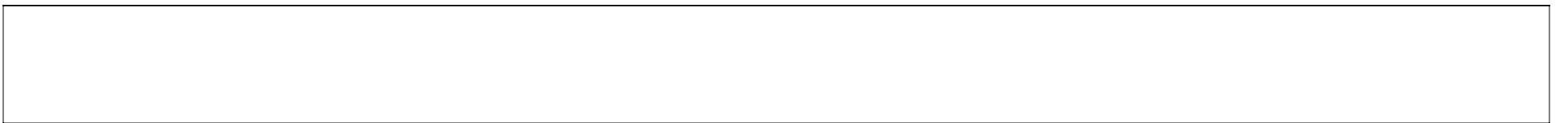
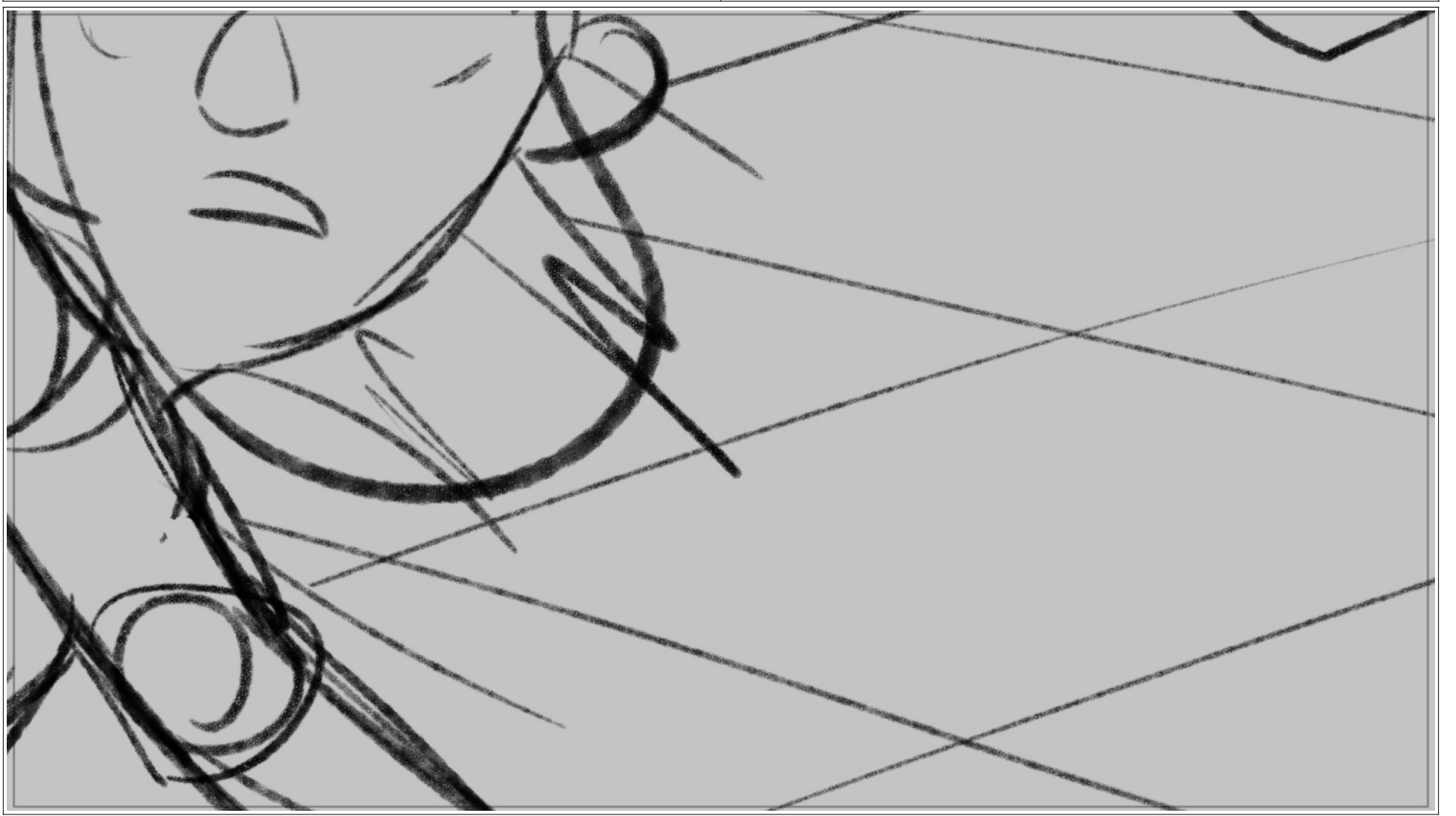

Scene	Panel
13	1

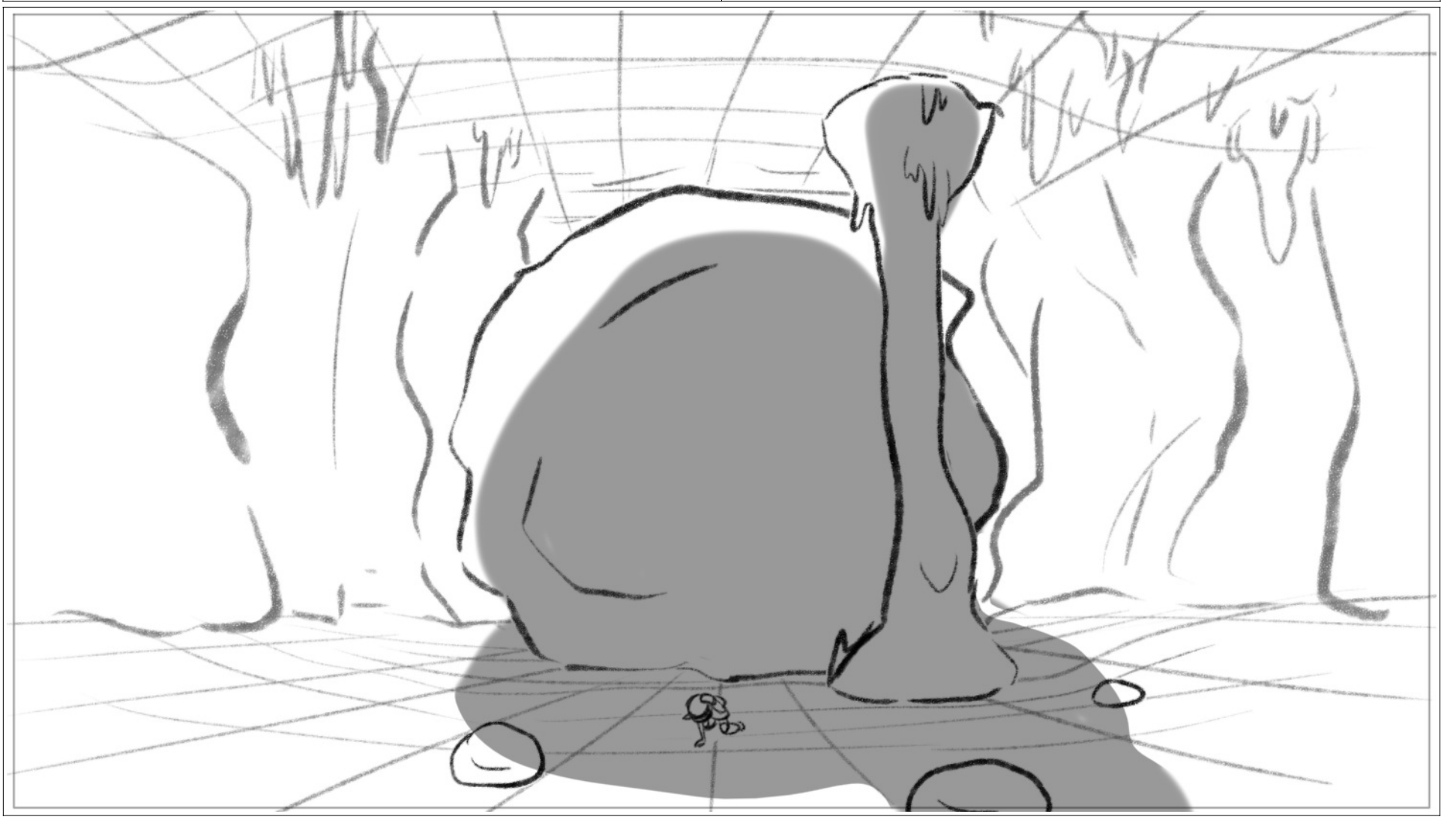

Scene	Panel
13	2

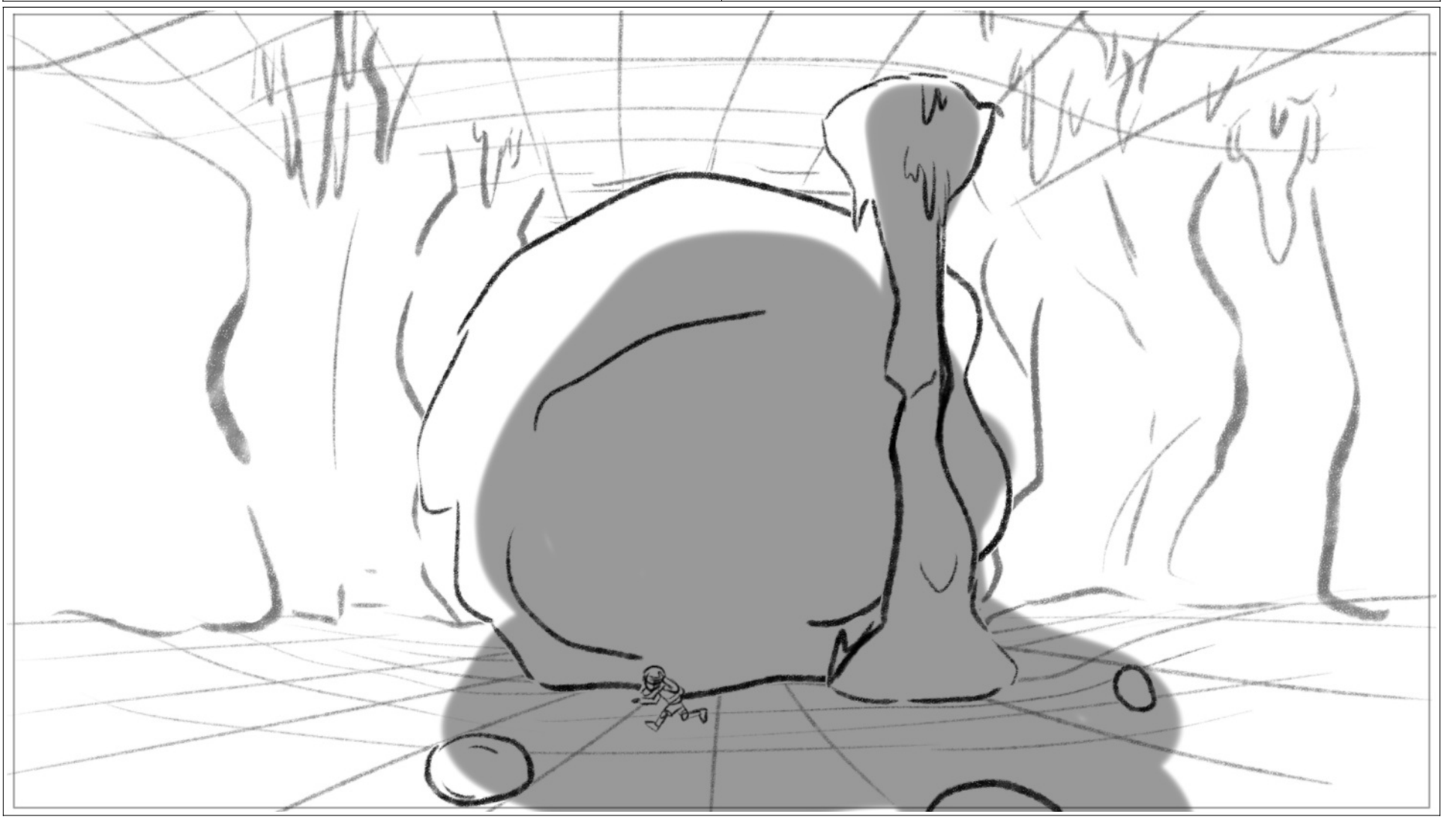

Scene	Panel
13	3

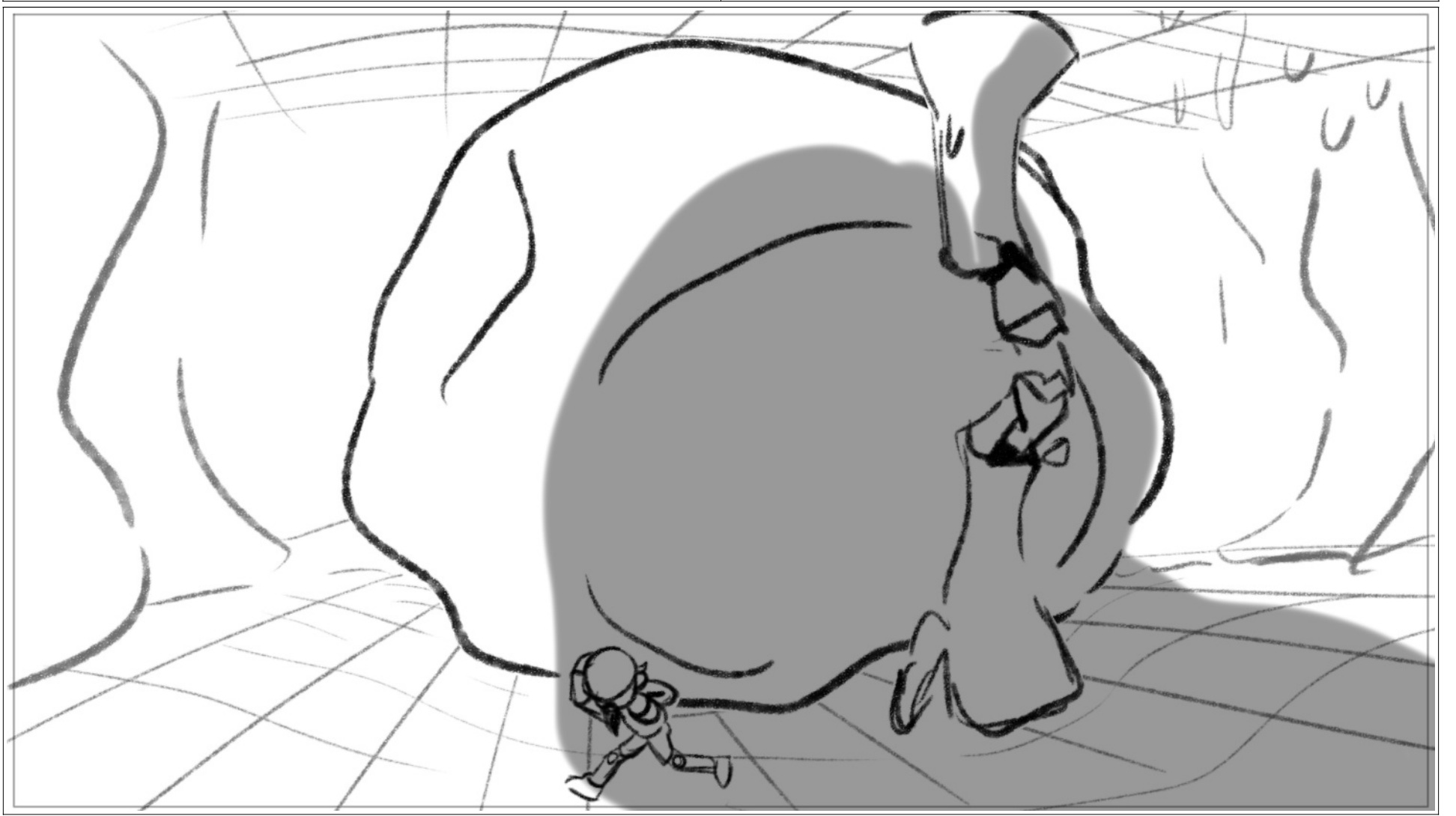

Scene	Panel
13	4

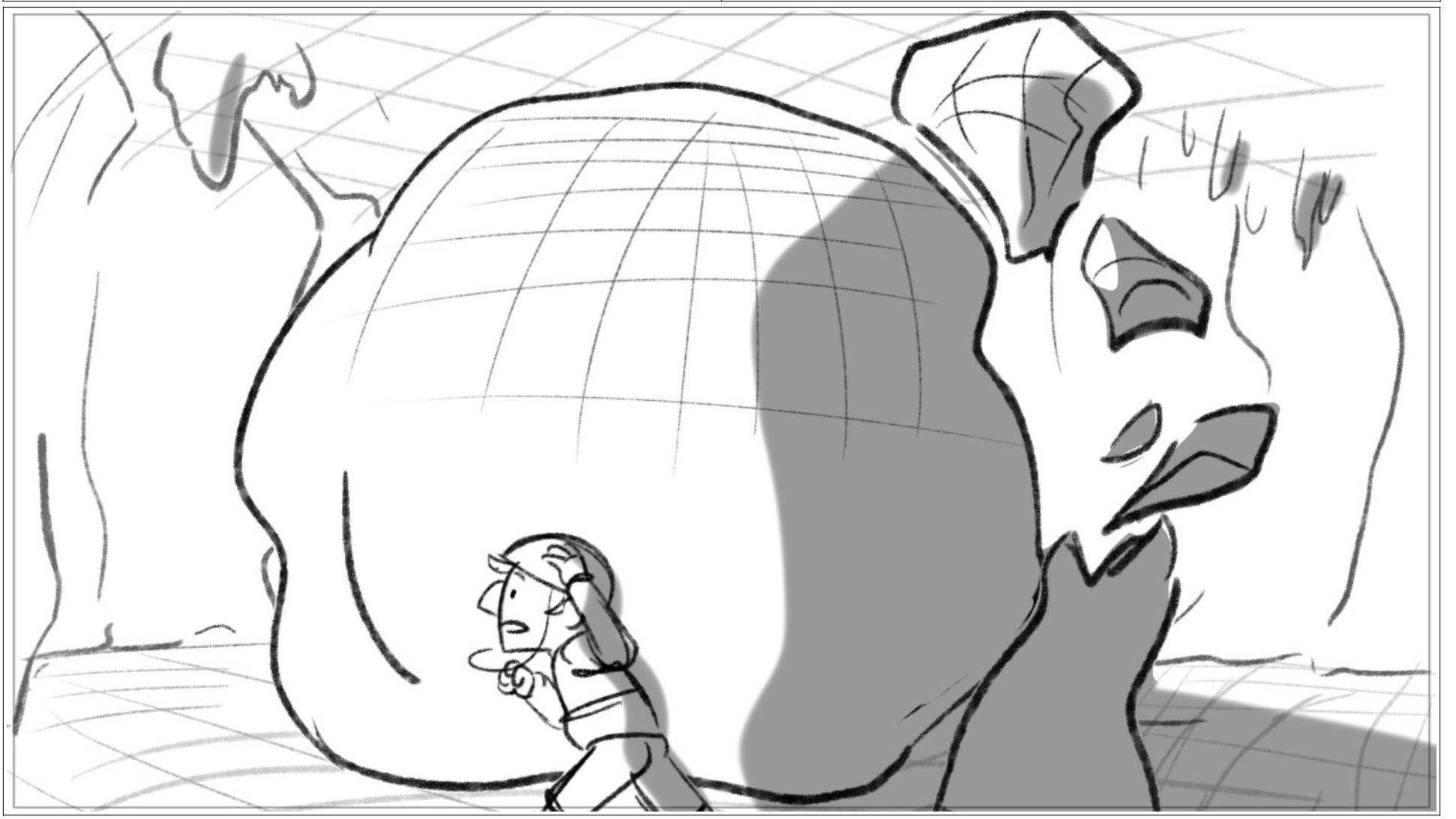

Scene	Panel
13	5

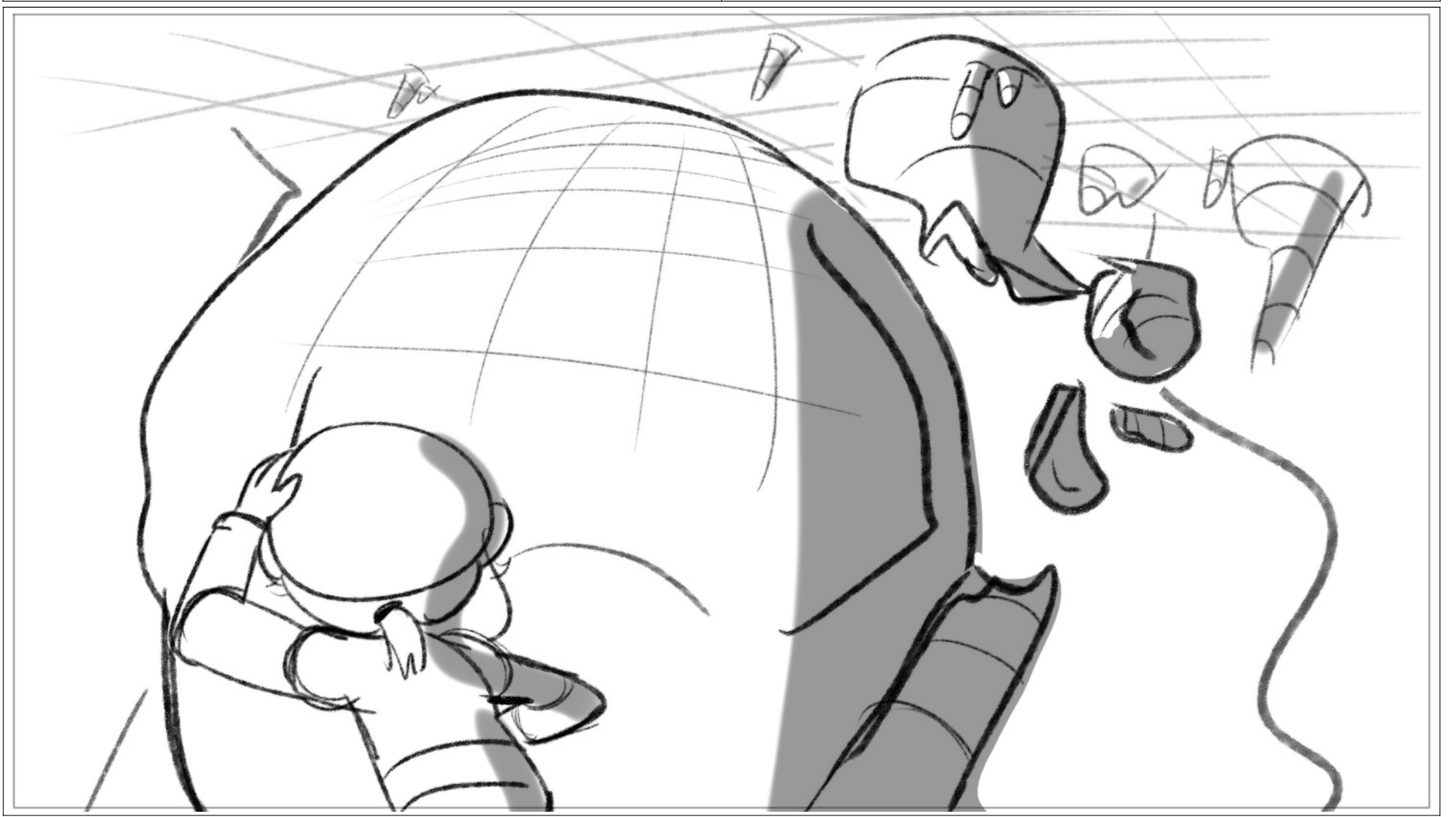

Scene	Panel
13	6

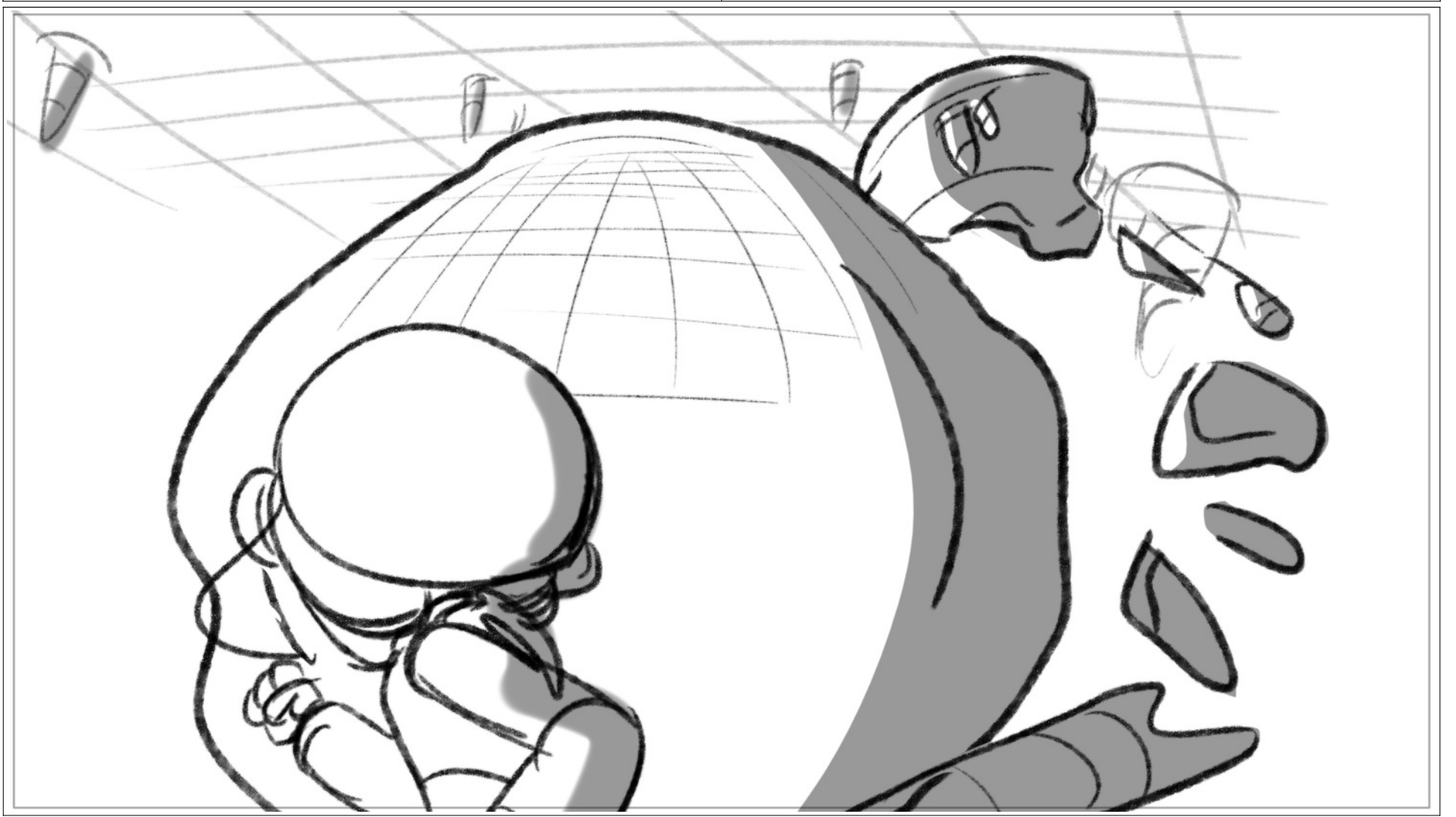

Scene	Panel
13	7

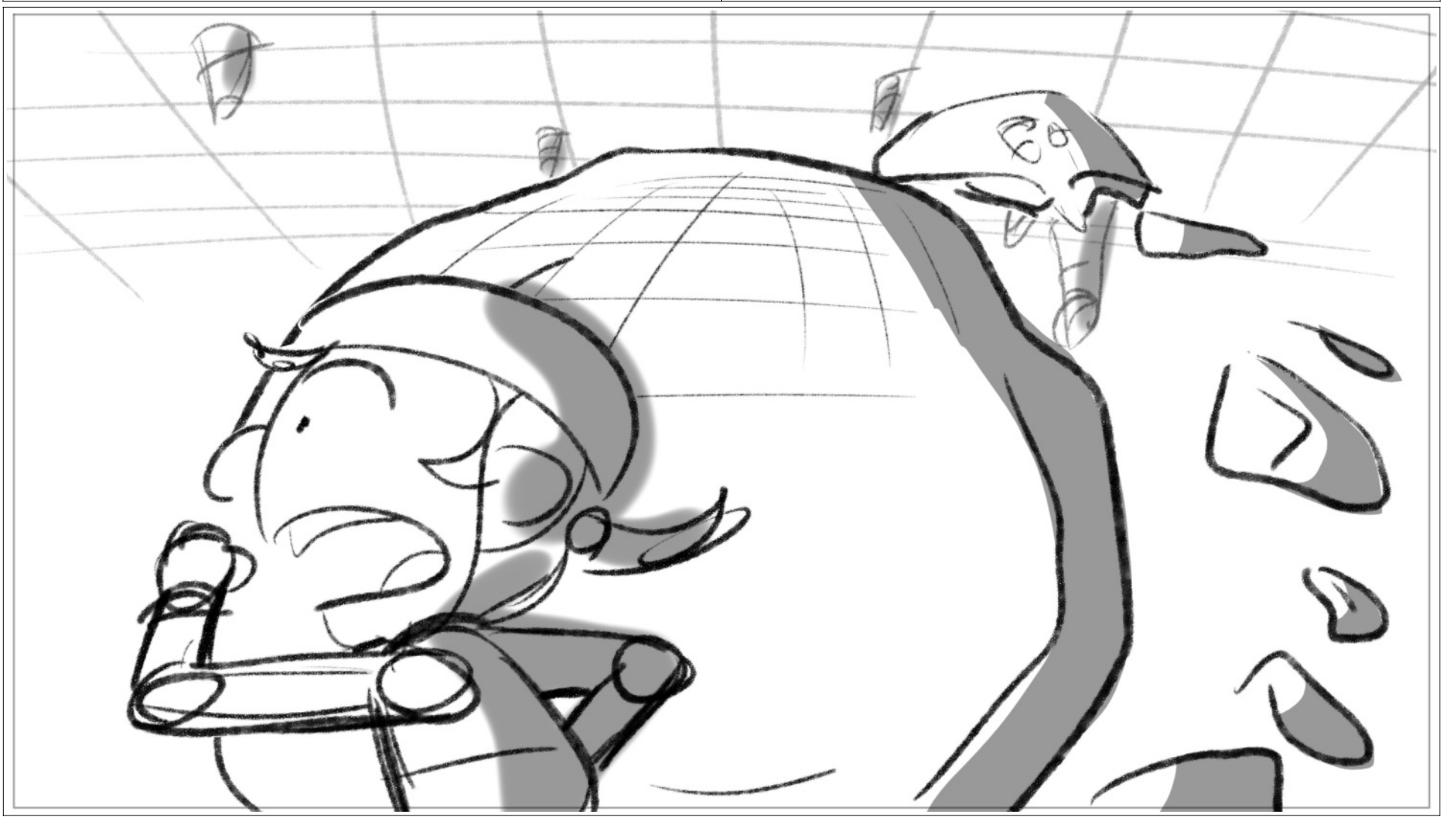

Scene	Panel
13	8

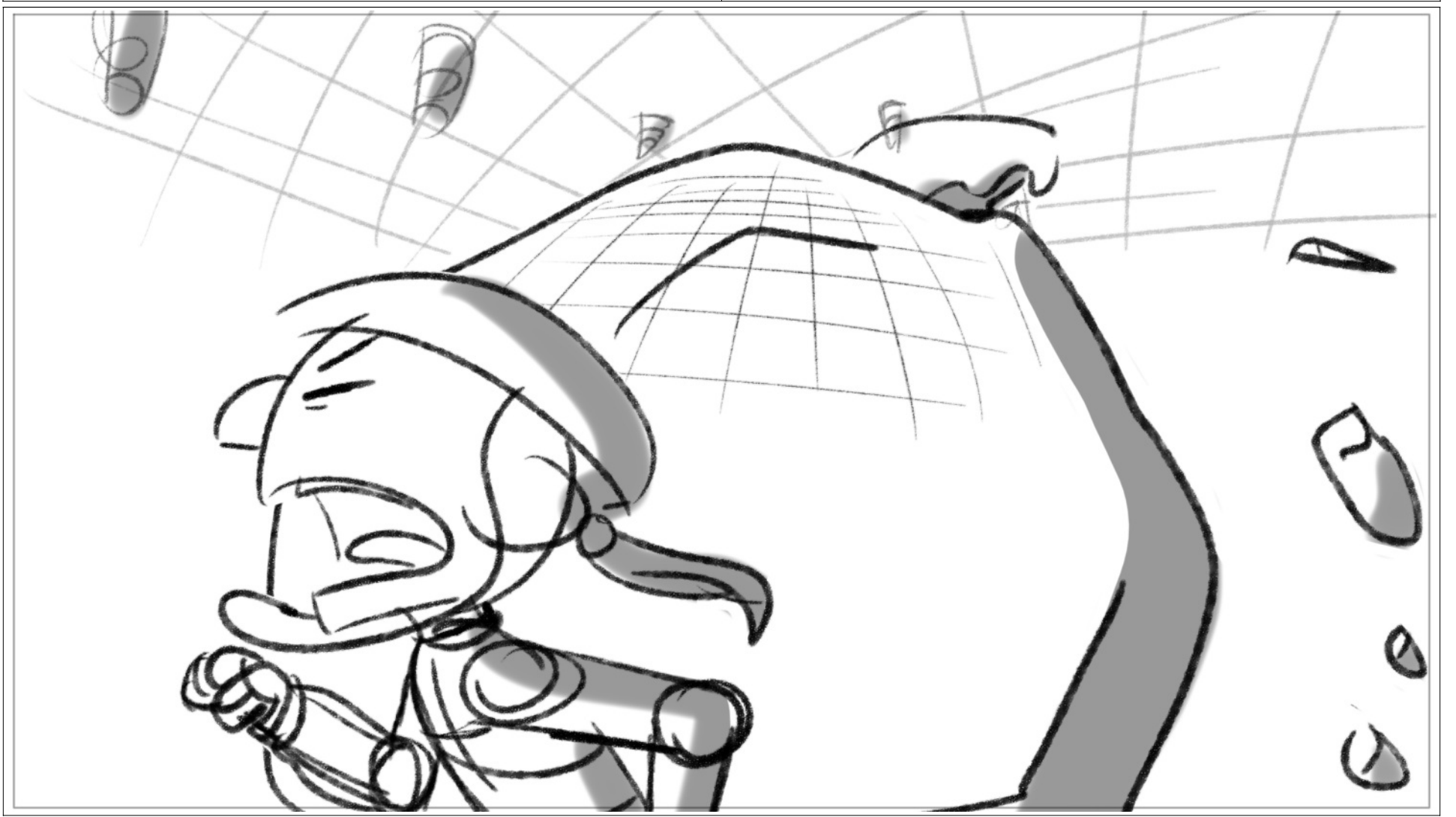

Scene	Panel
14	1

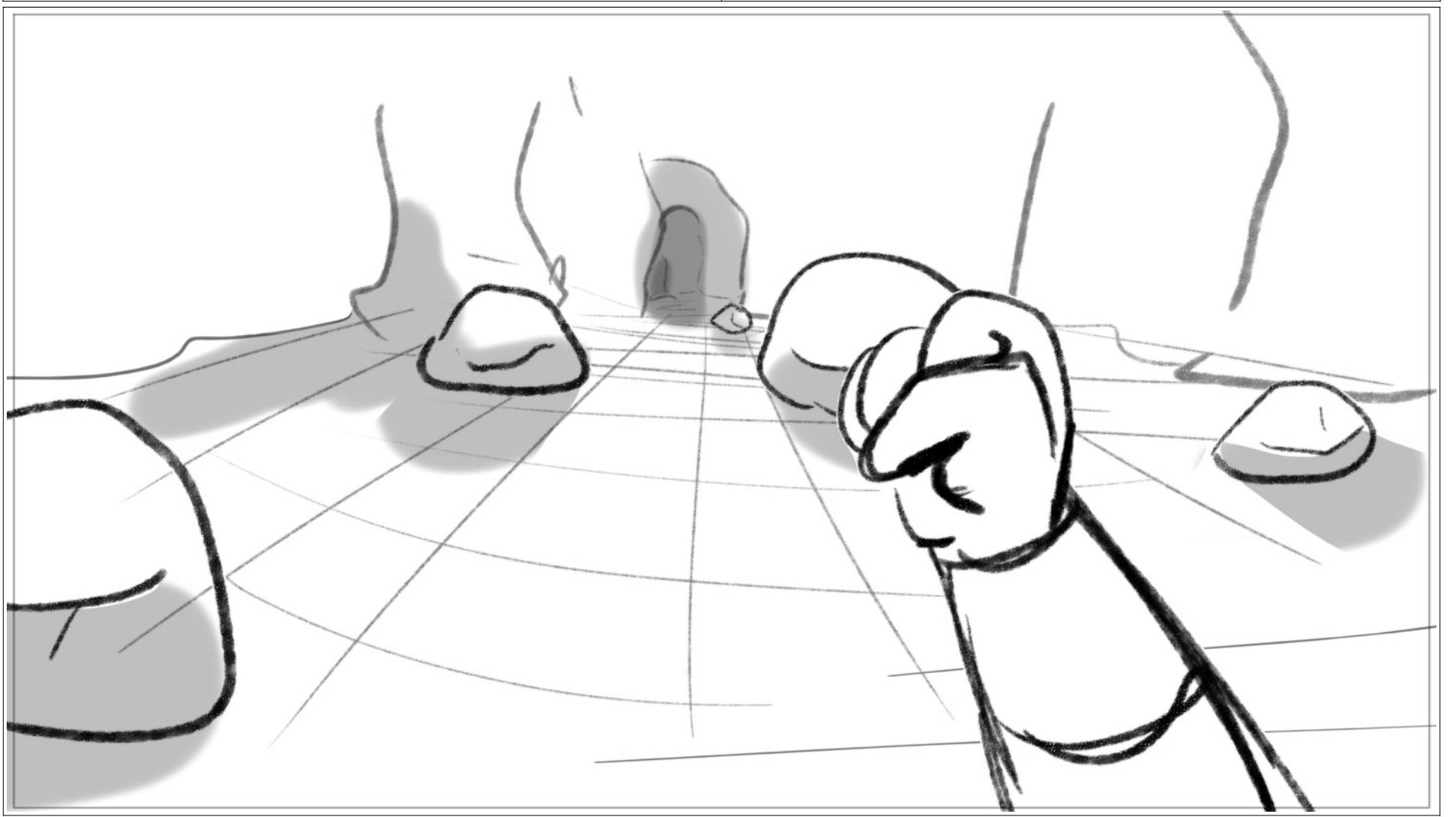

Scene	Panel
14	2

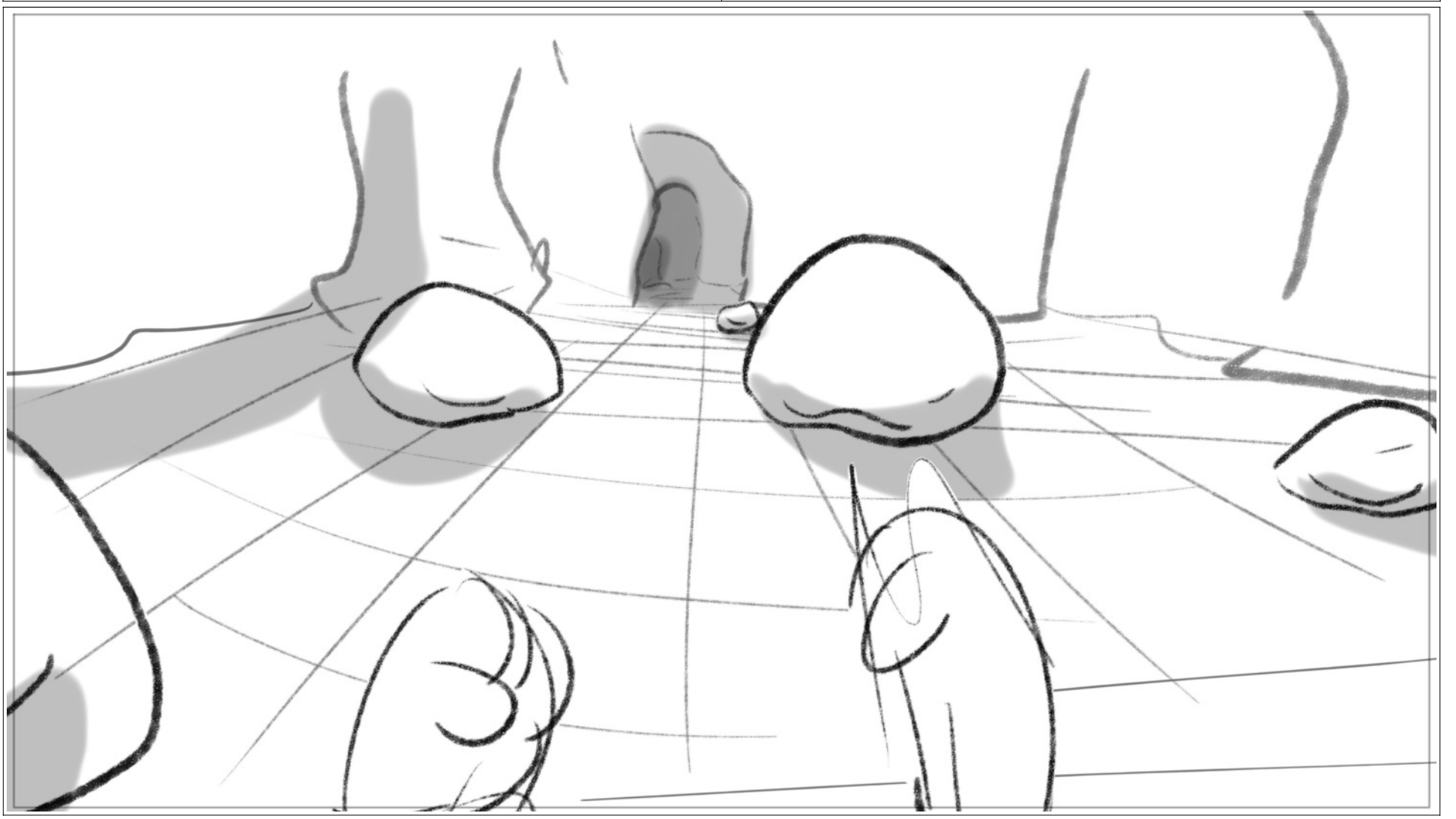

Scene	Panel
14	3

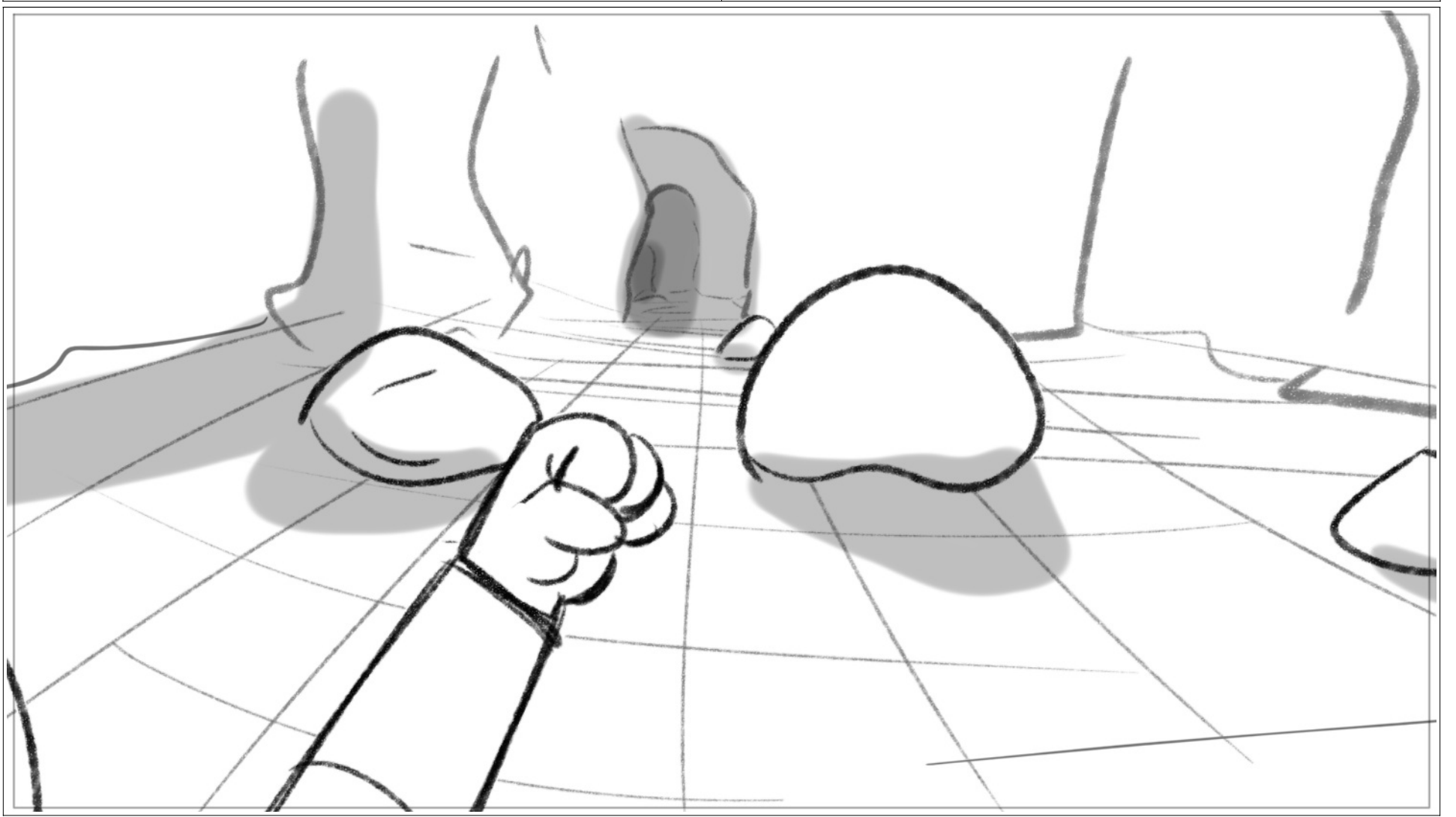

Scene	Panel
14	4

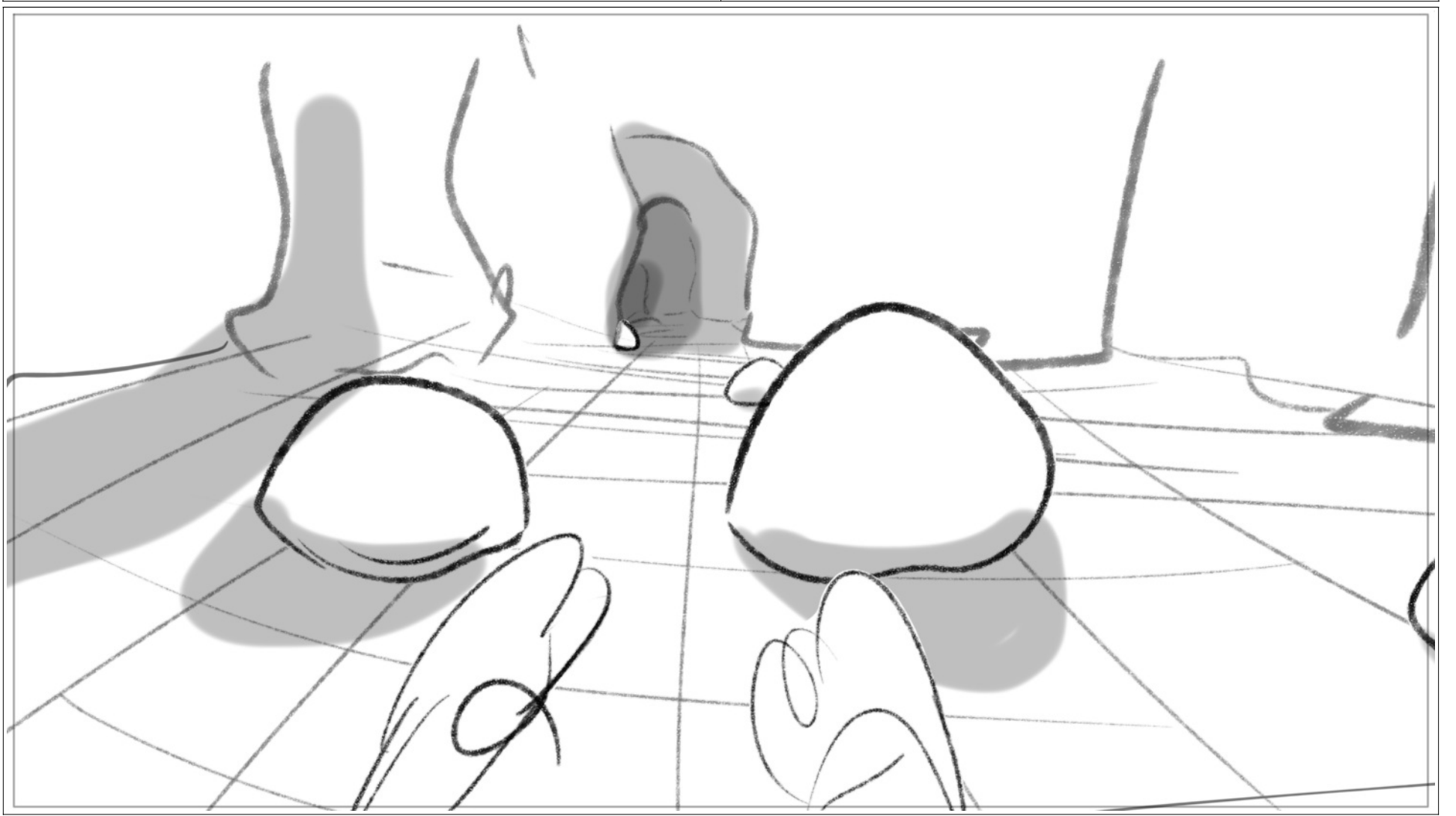

Empty space for notes or dialogue.

Scene 14	Panel 5
-------------	------------

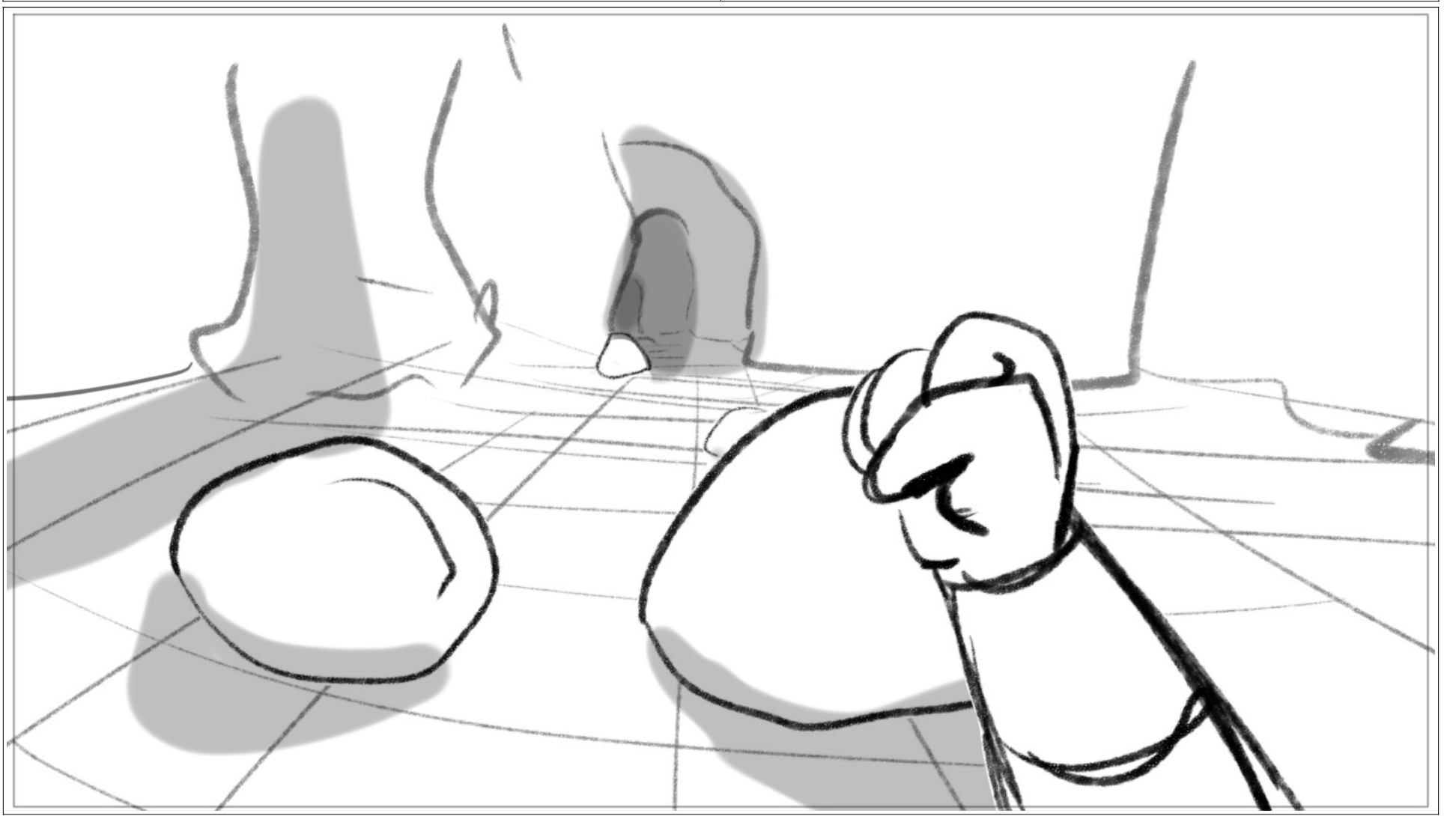

Scene 15	Panel 1
-------------	------------

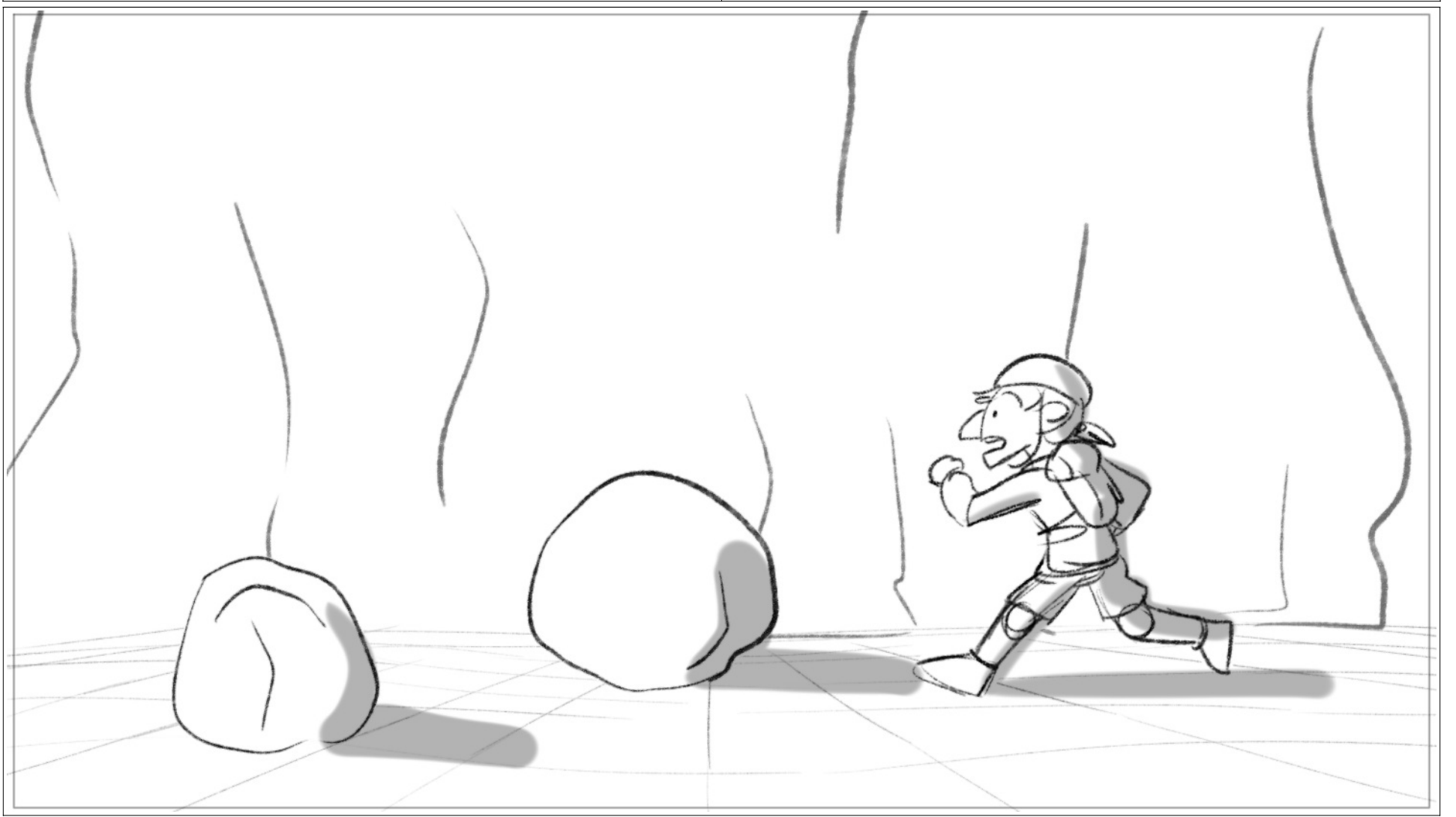

Scene	Panel
15	2

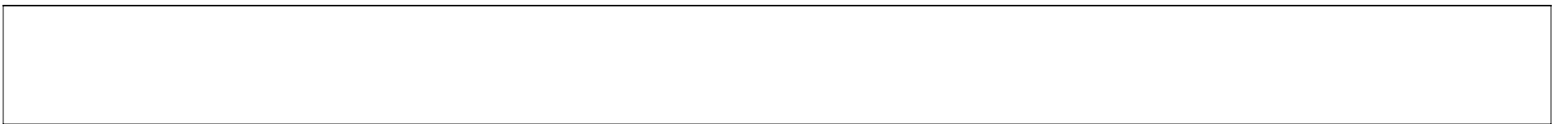
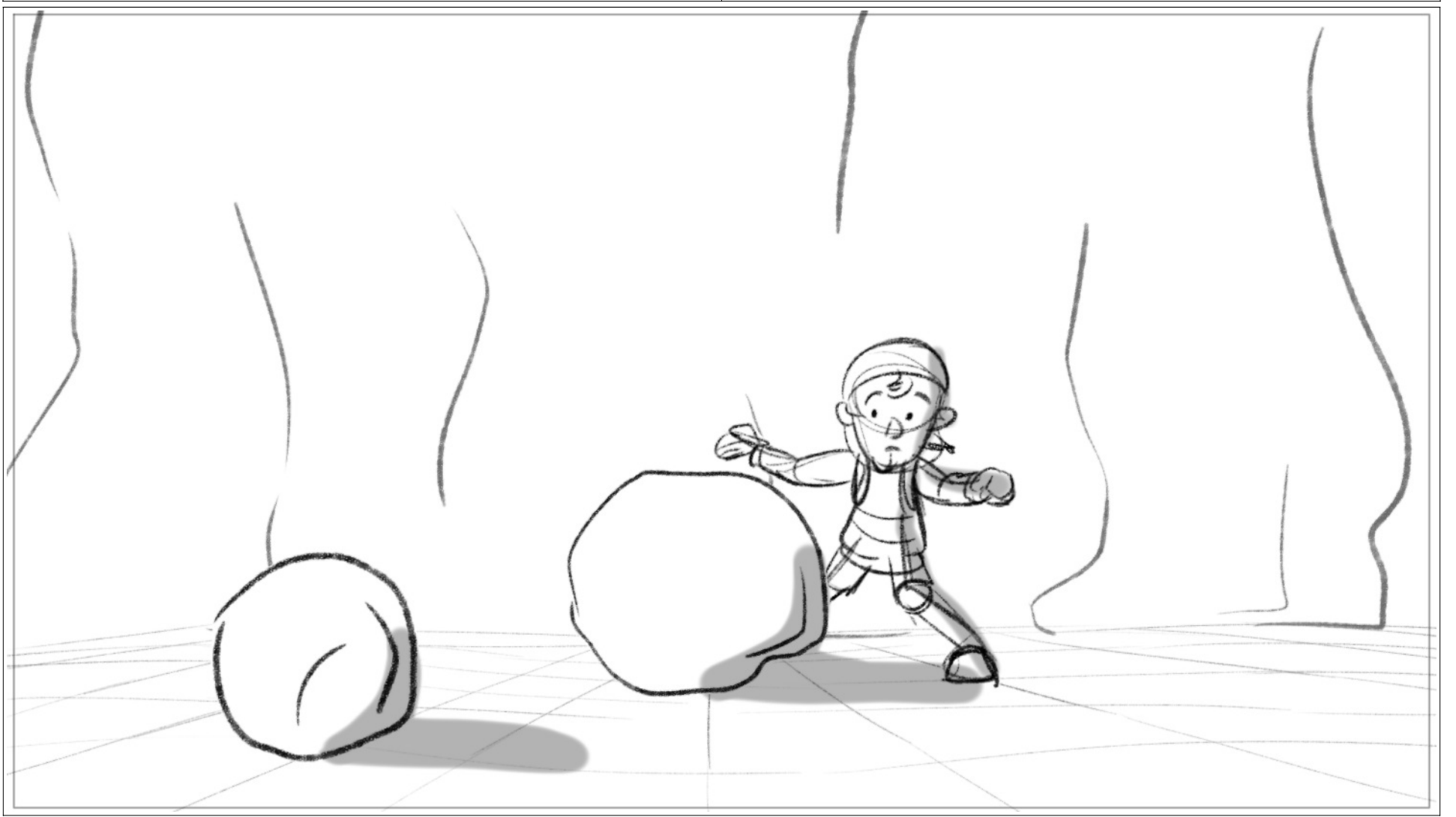

Scene	Panel
15	3

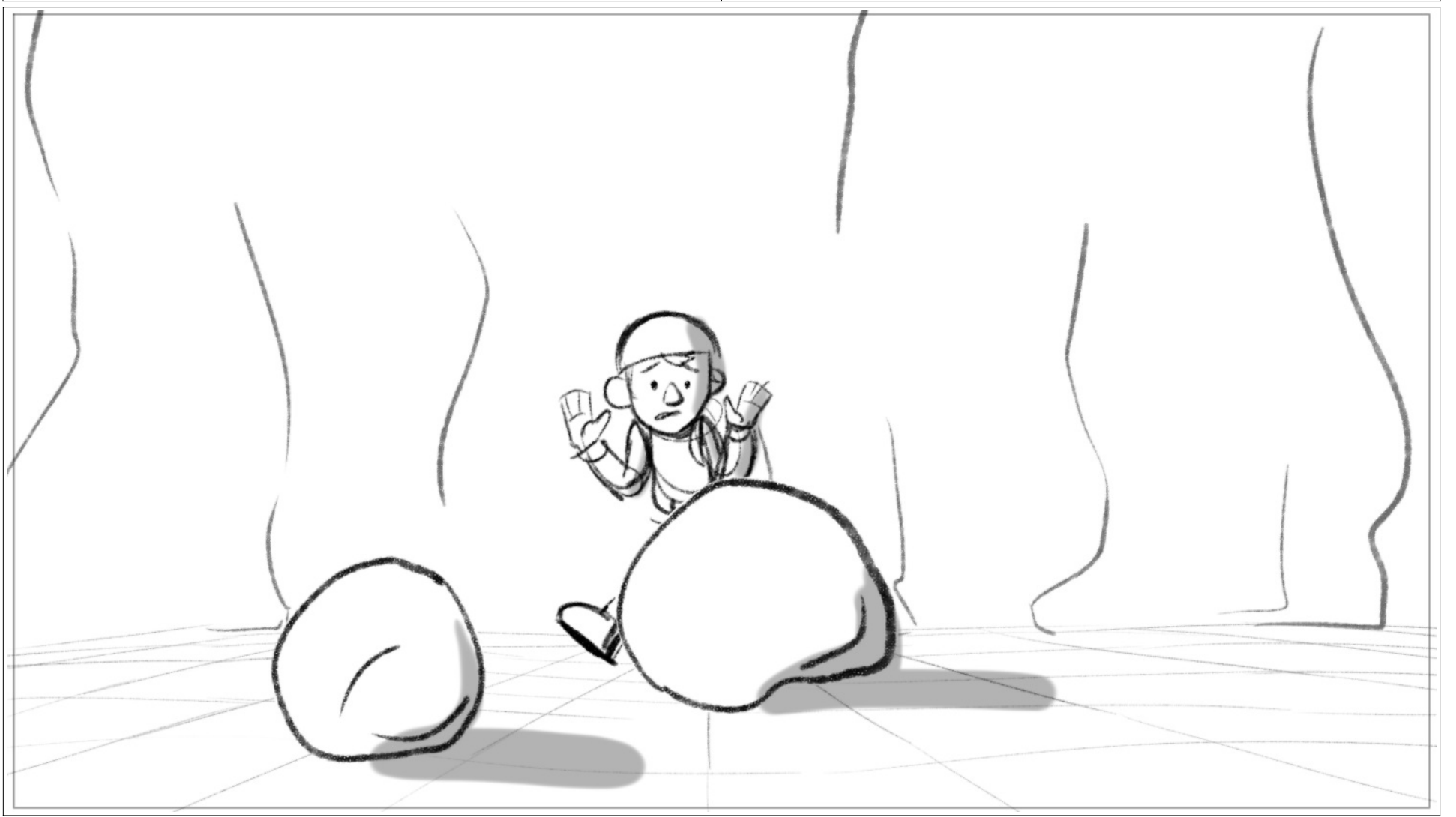

Scene	Panel
15	4

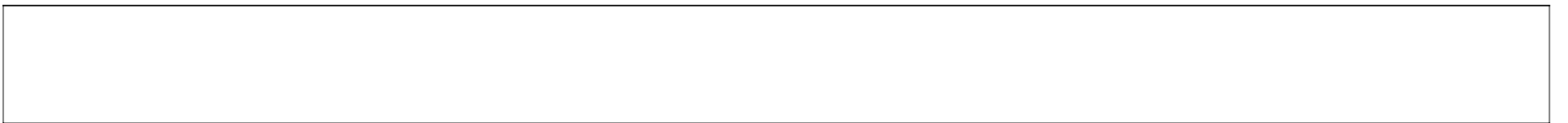
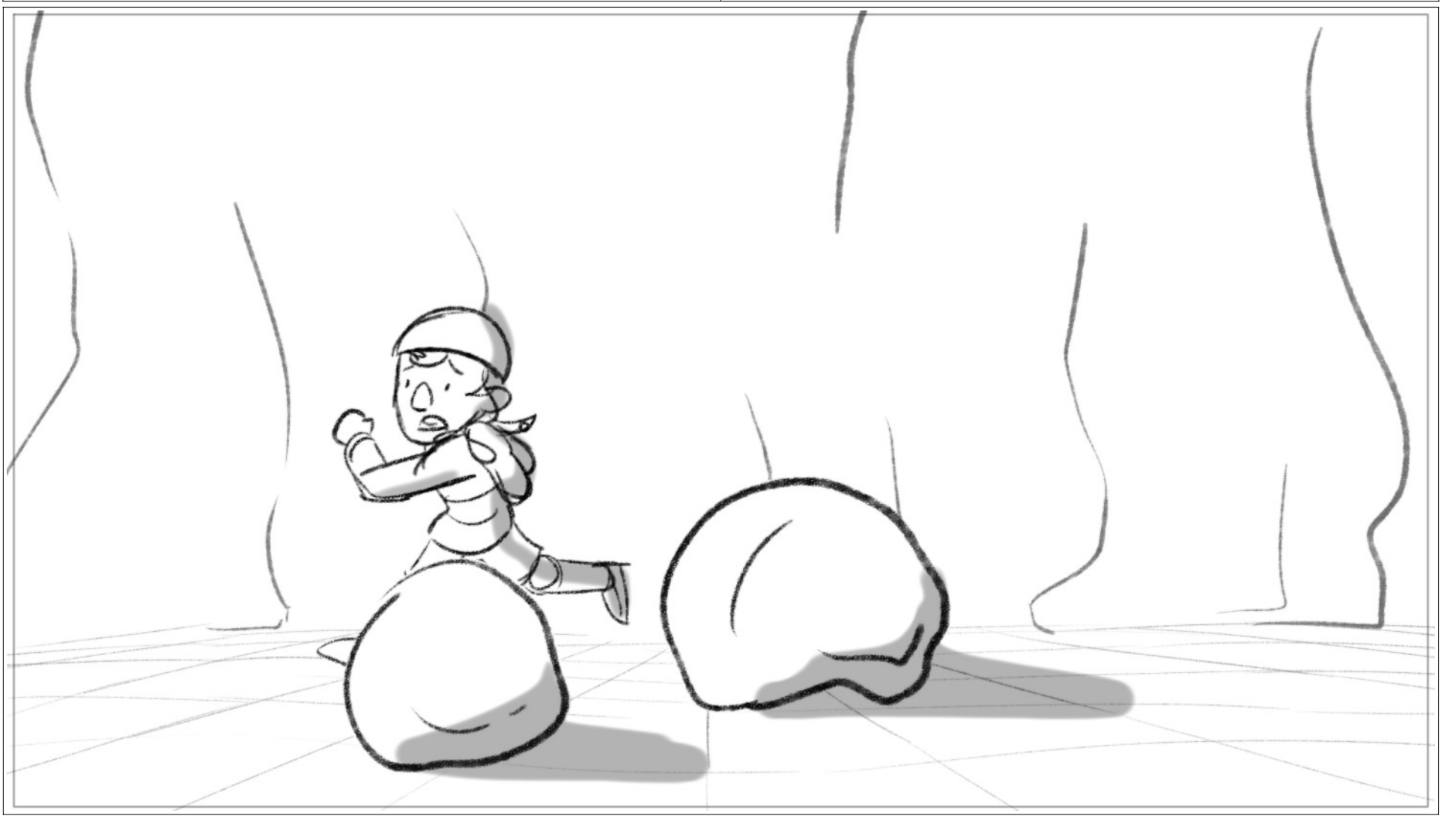

Scene 16	Panel 1
-------------	------------

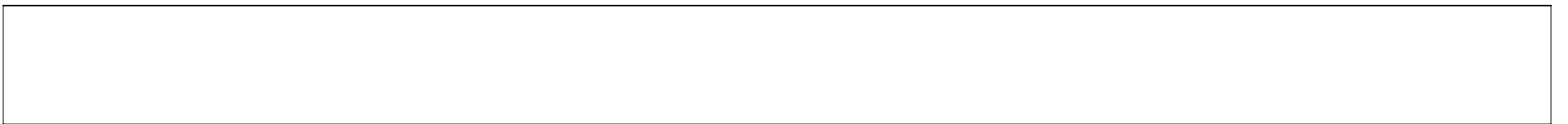

Scene	Panel
16	2

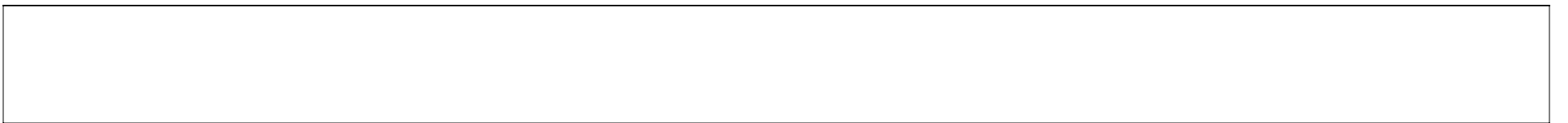

Scene 17	Panel 1
-------------	------------

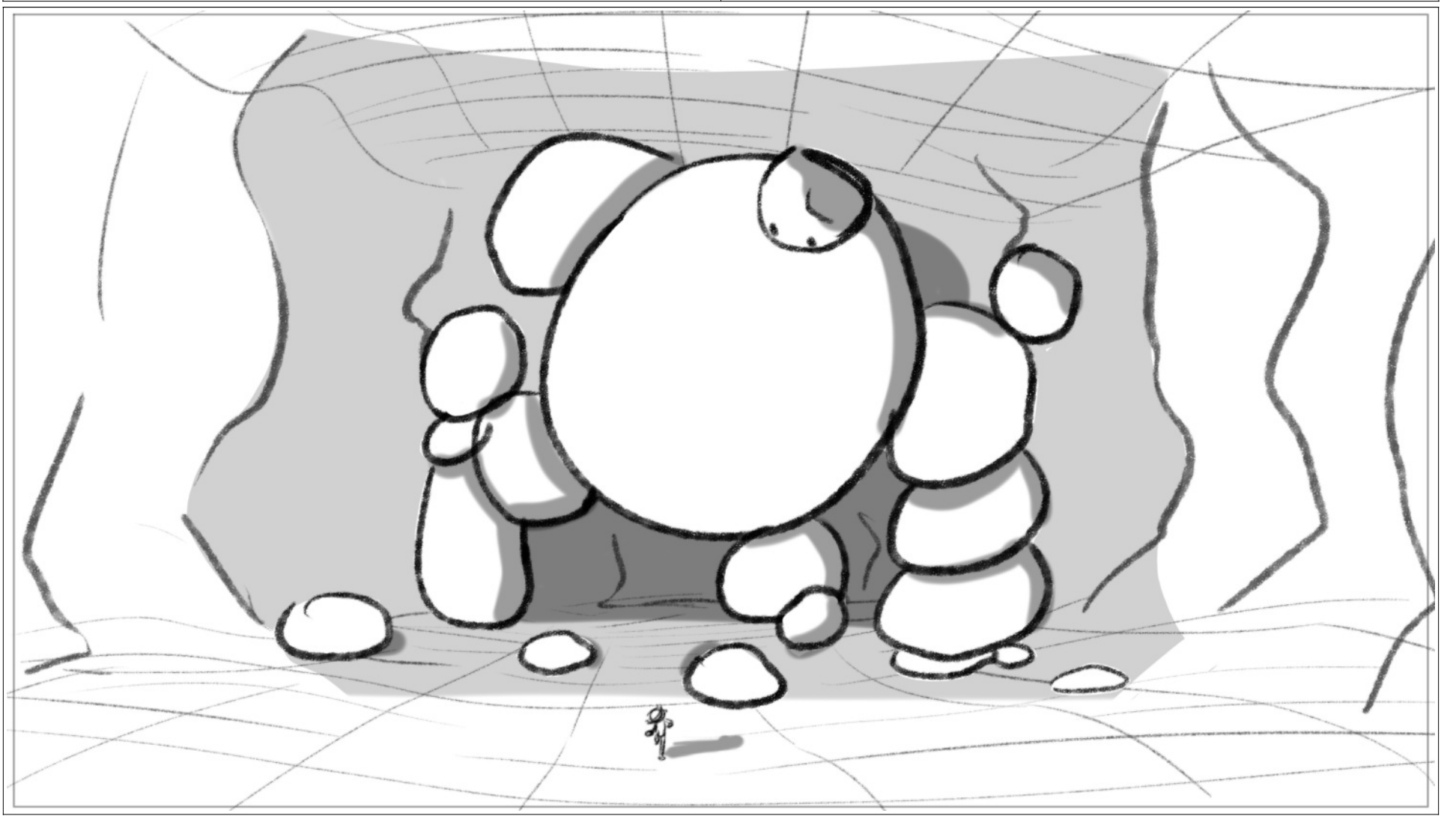

Scene 17	Panel 2
-------------	------------

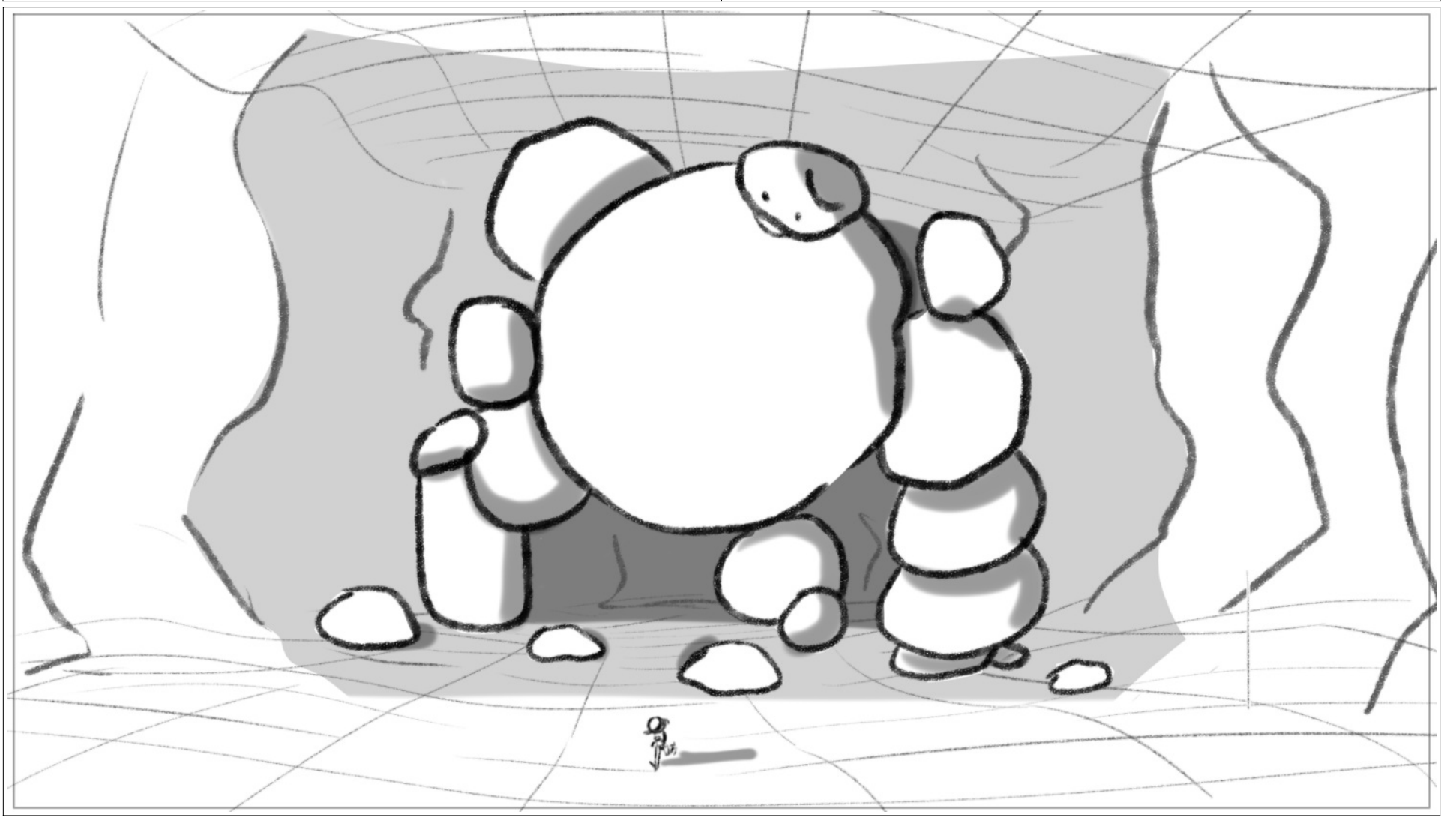

Scene 17	Panel 3
-------------	------------

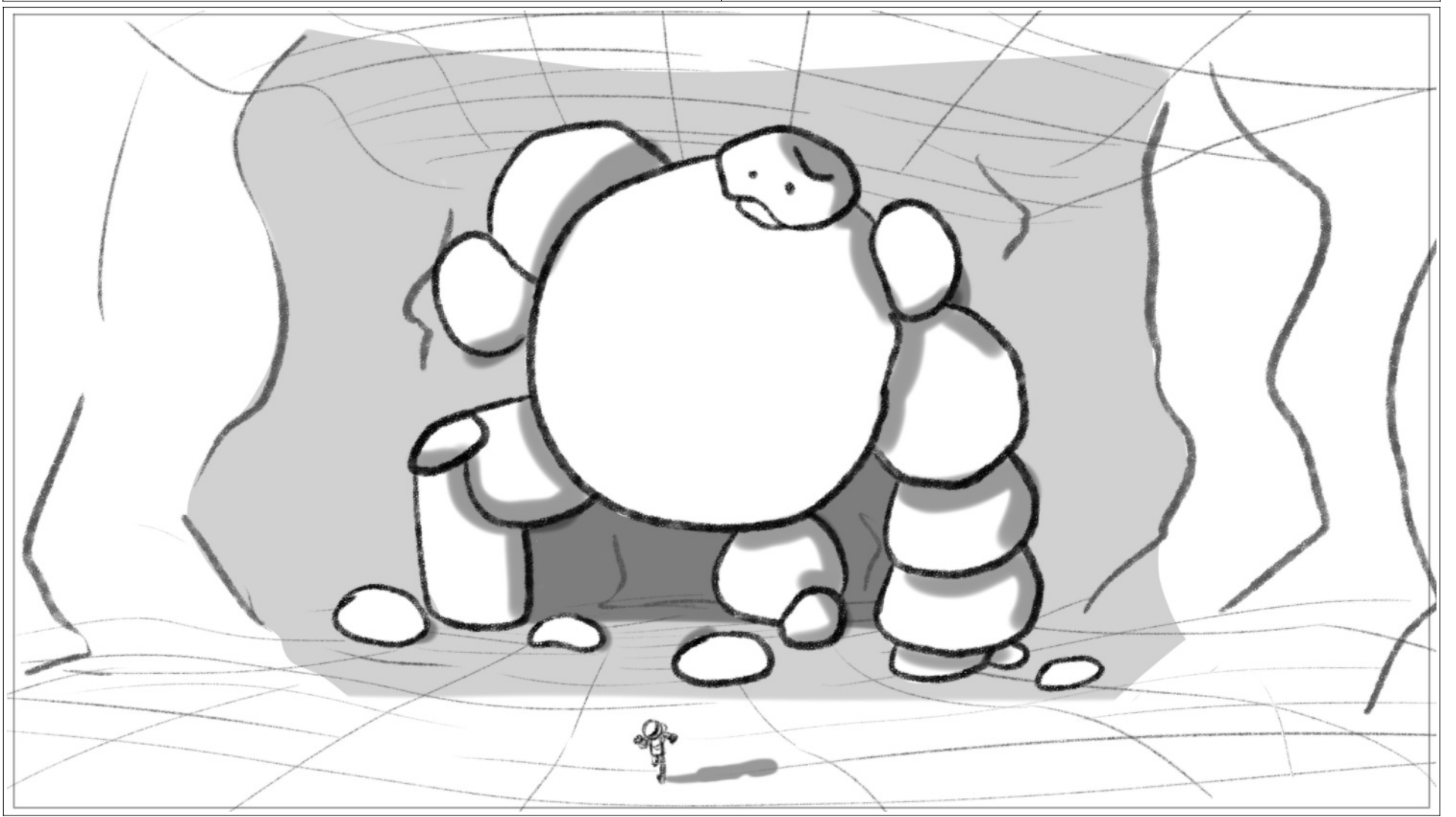

Scene 18	Panel 1
-------------	------------

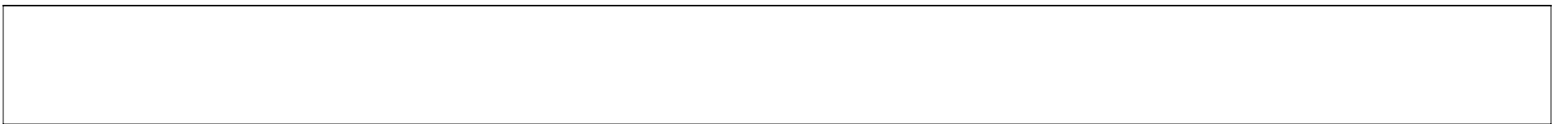

Scene	Panel
18	2

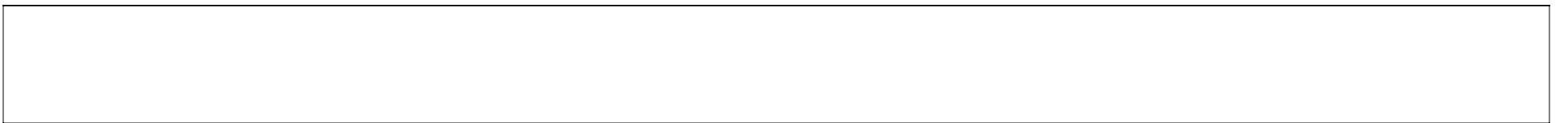

Scene 18	Panel 3
-------------	------------



Scene	Panel
18	4

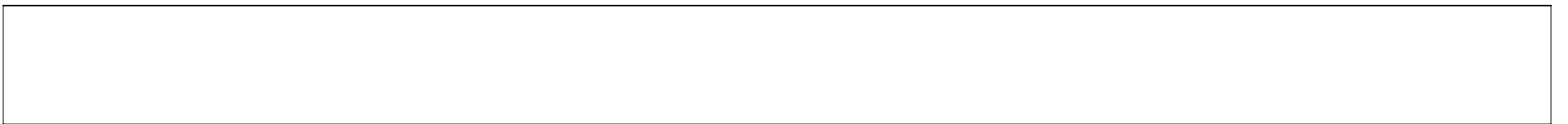

Scene 18	Panel 5
-------------	------------

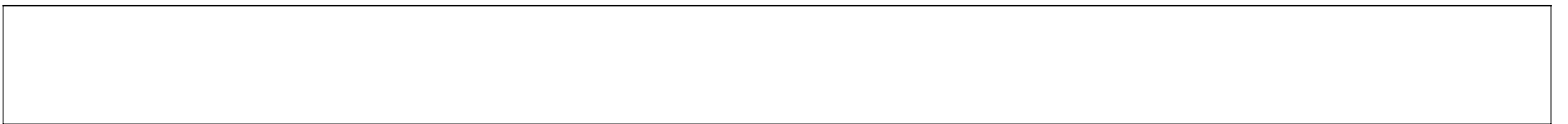

Scene 18	Panel 6
-------------	------------

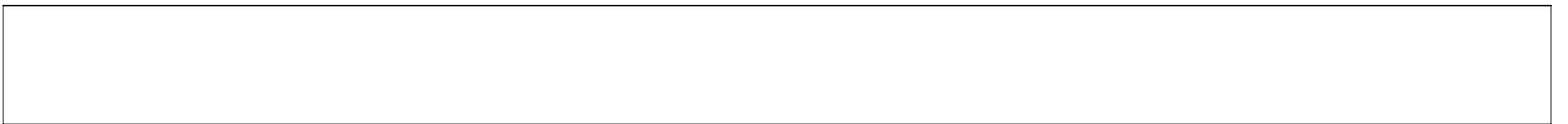

Scene	Panel
19	1

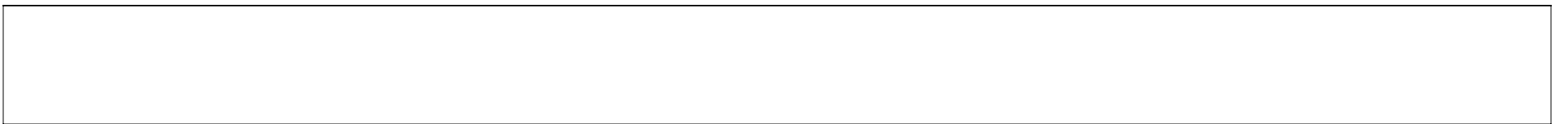
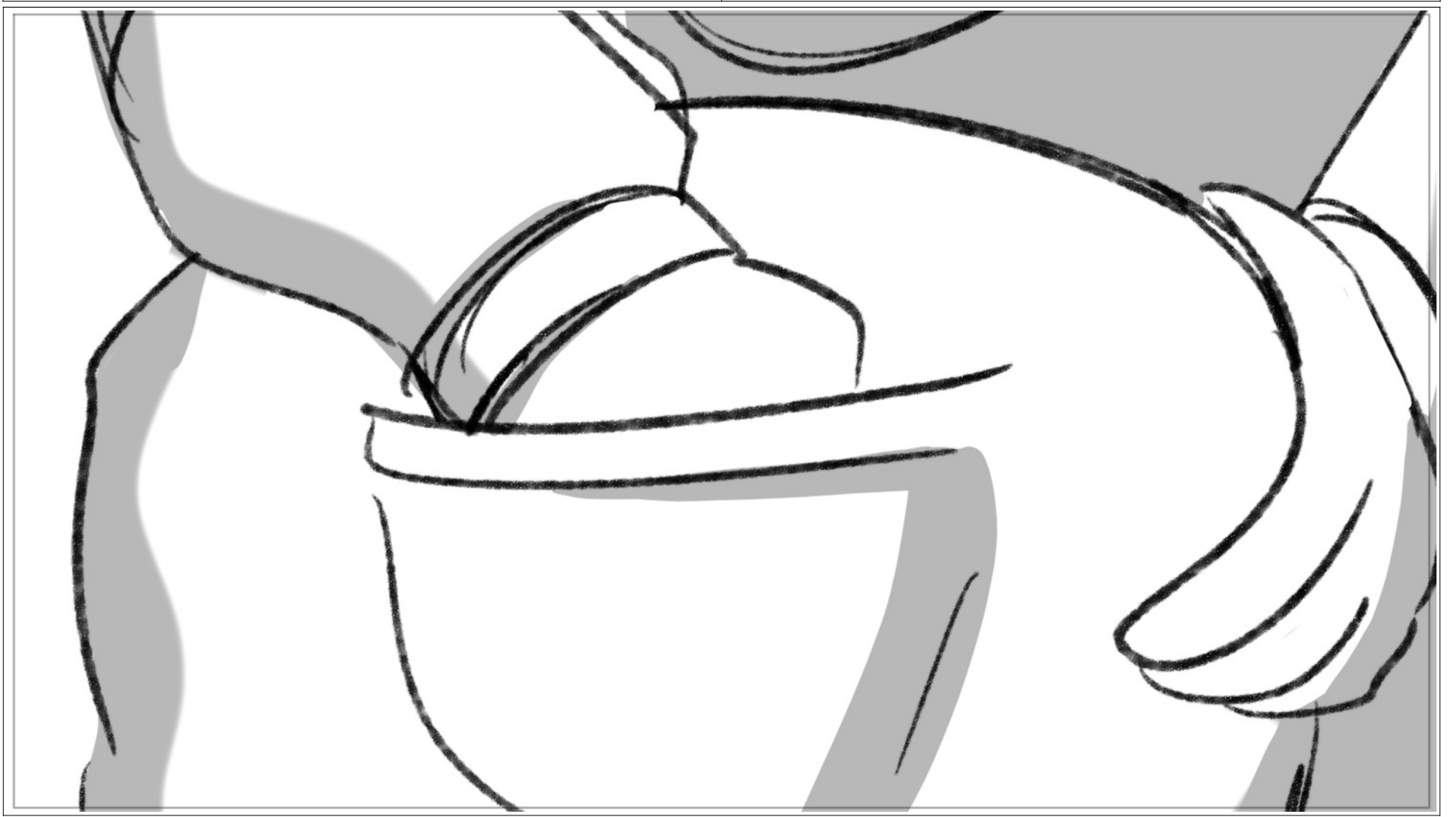

Scene	Panel
19	2

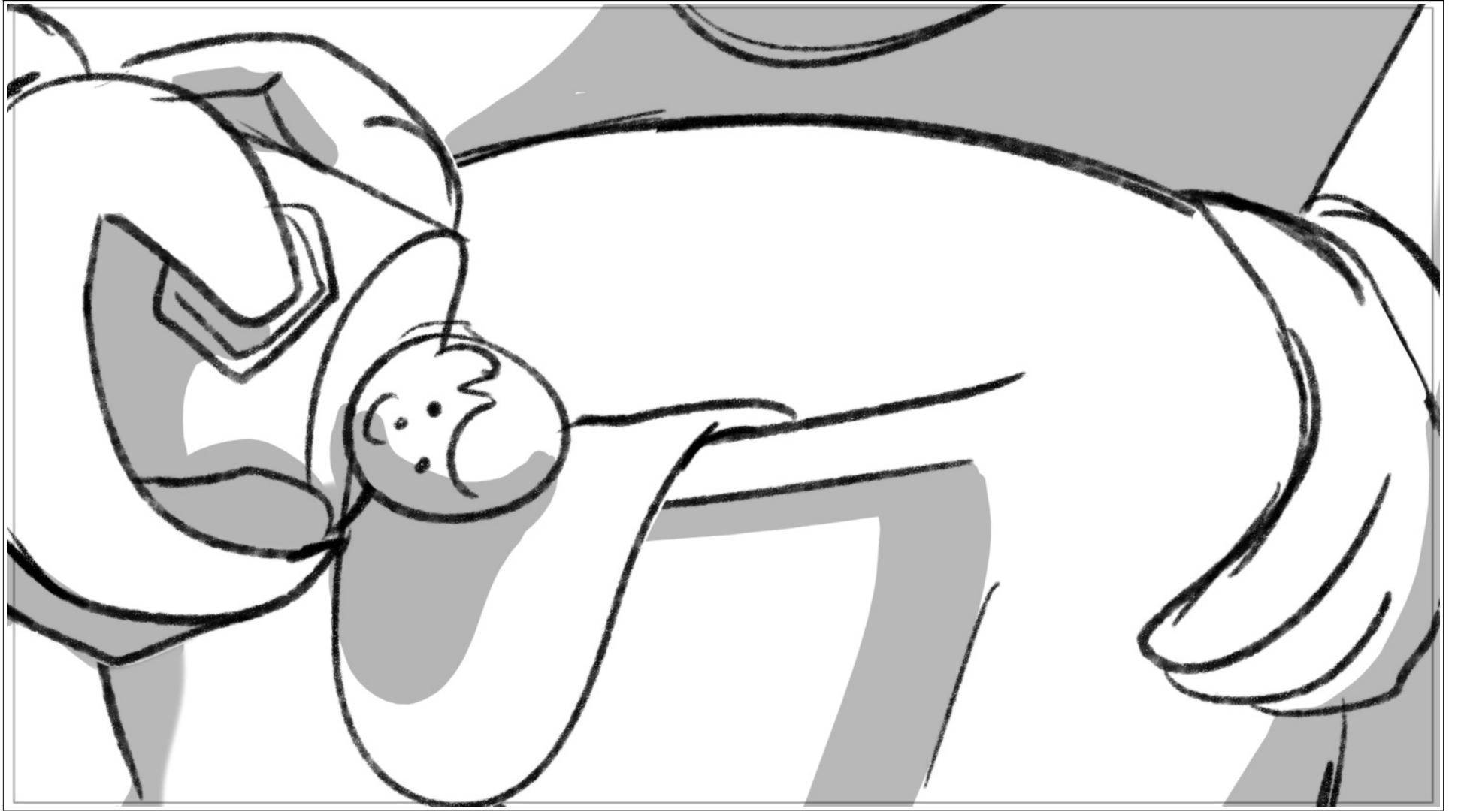

Scene	Panel
20	1

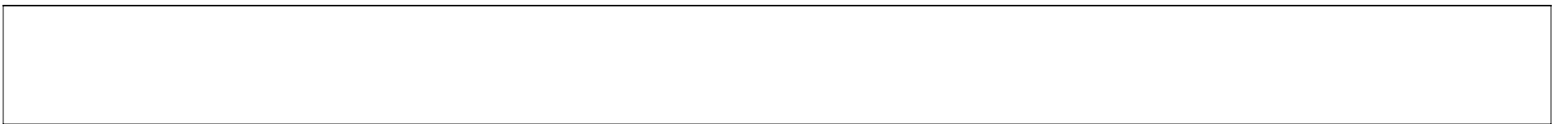
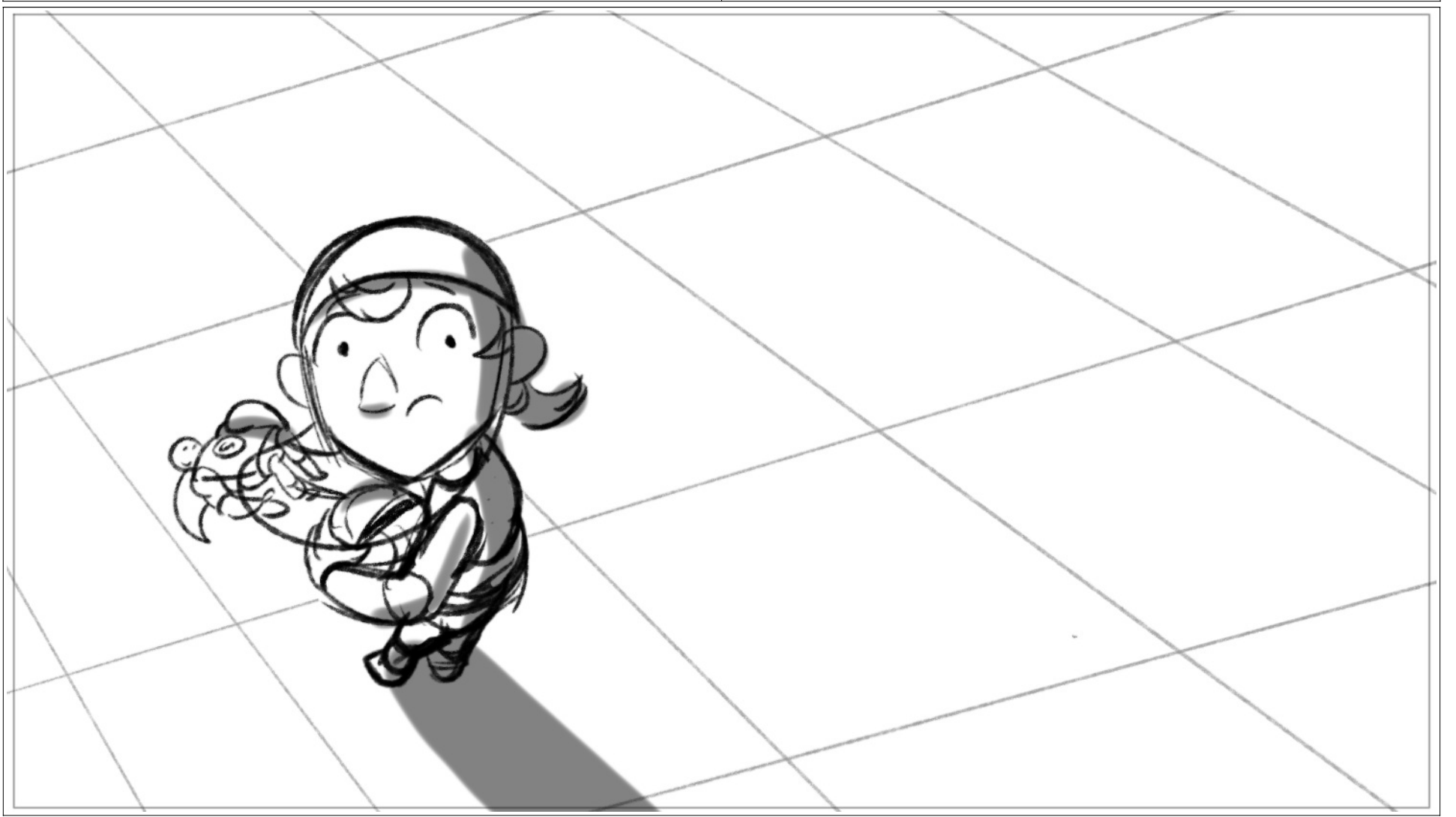

Scene	Panel
20	2

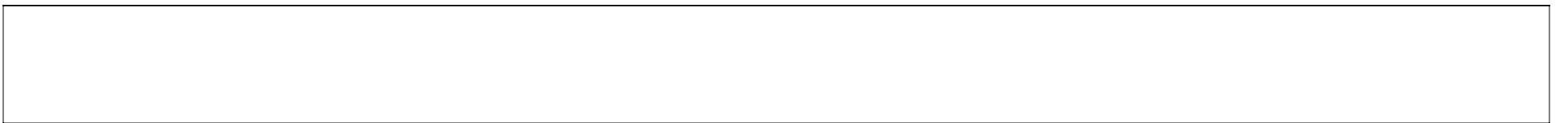
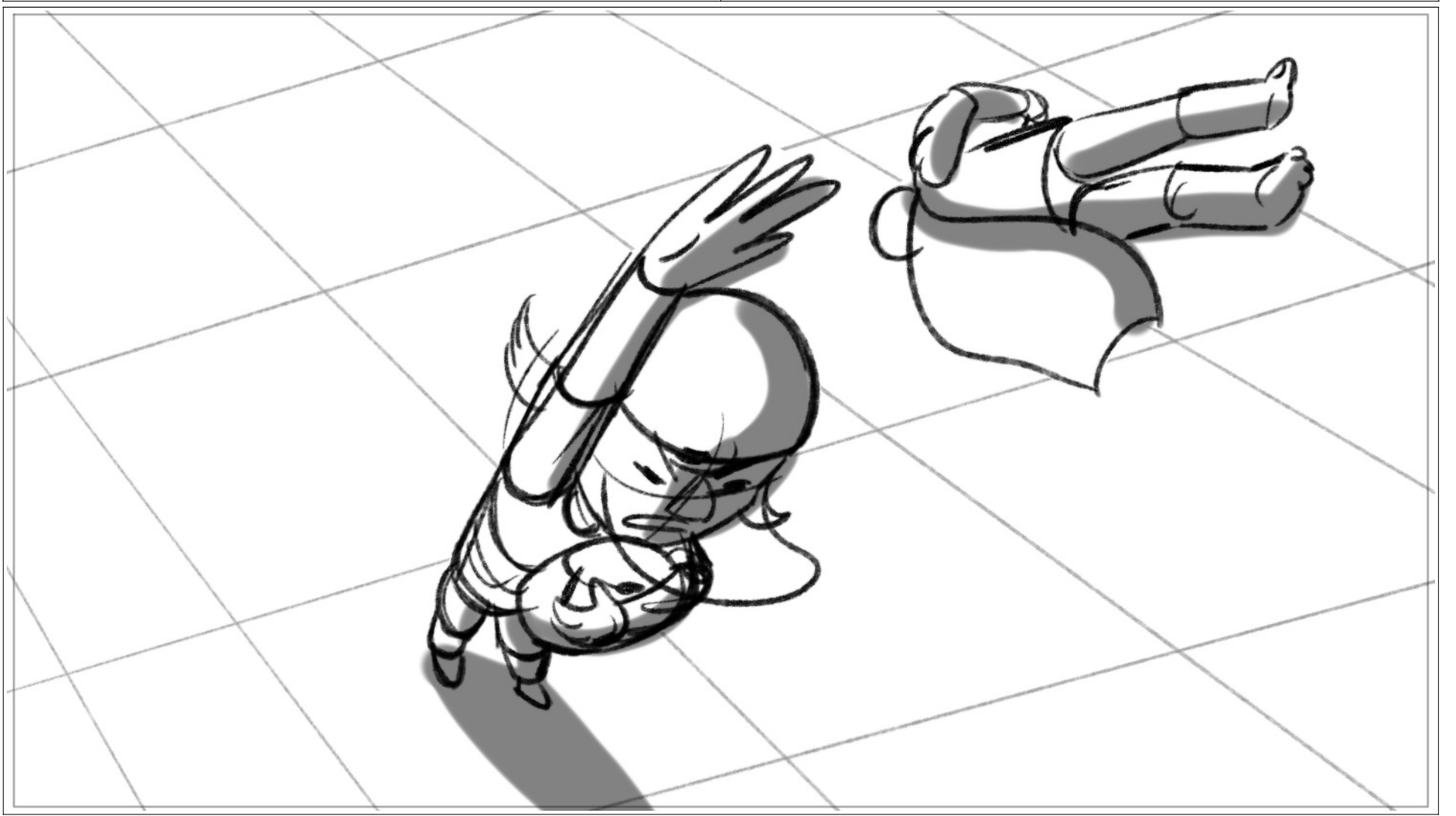

Scene	Panel
21	1

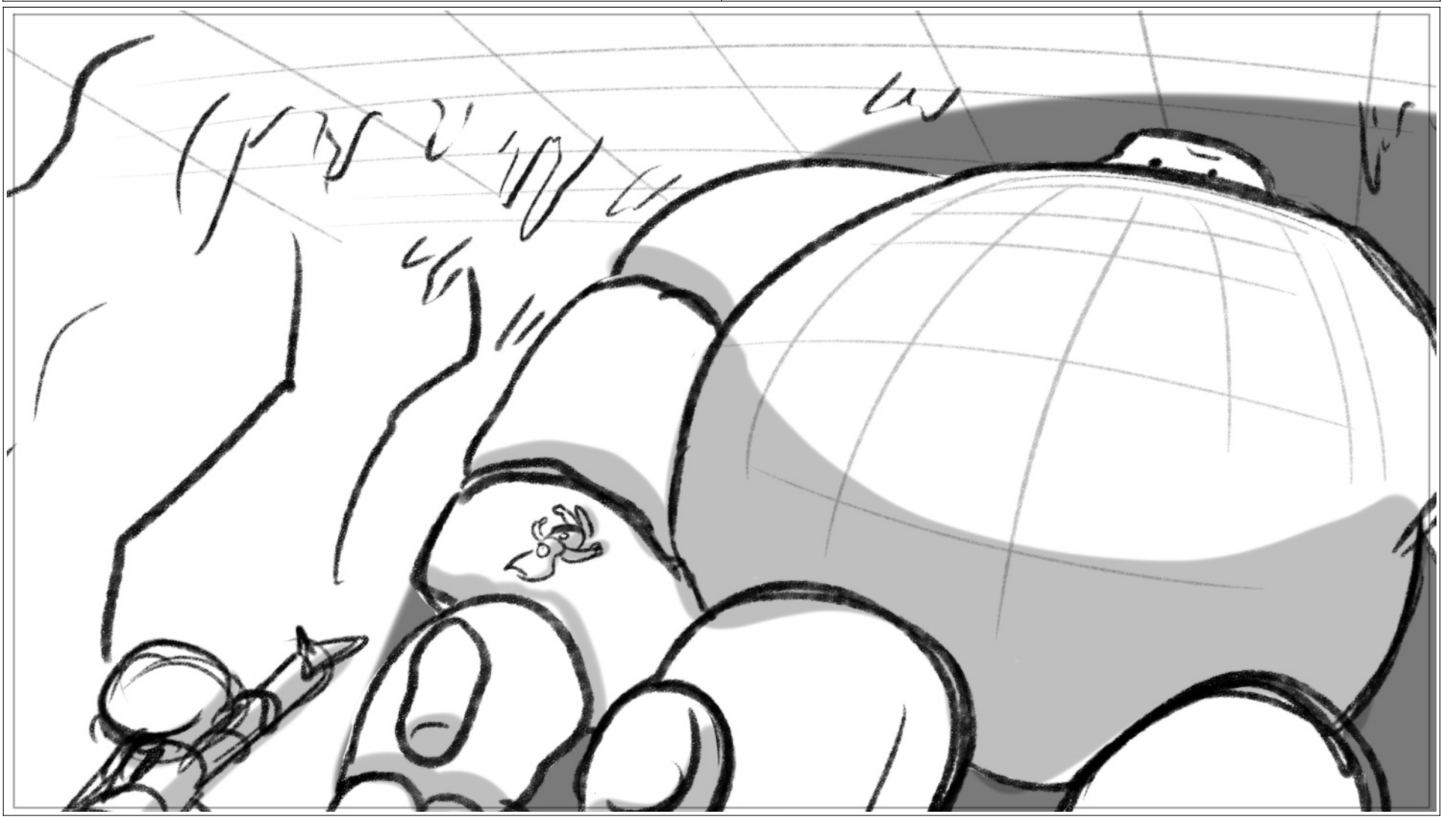

Scene	Panel
21	2

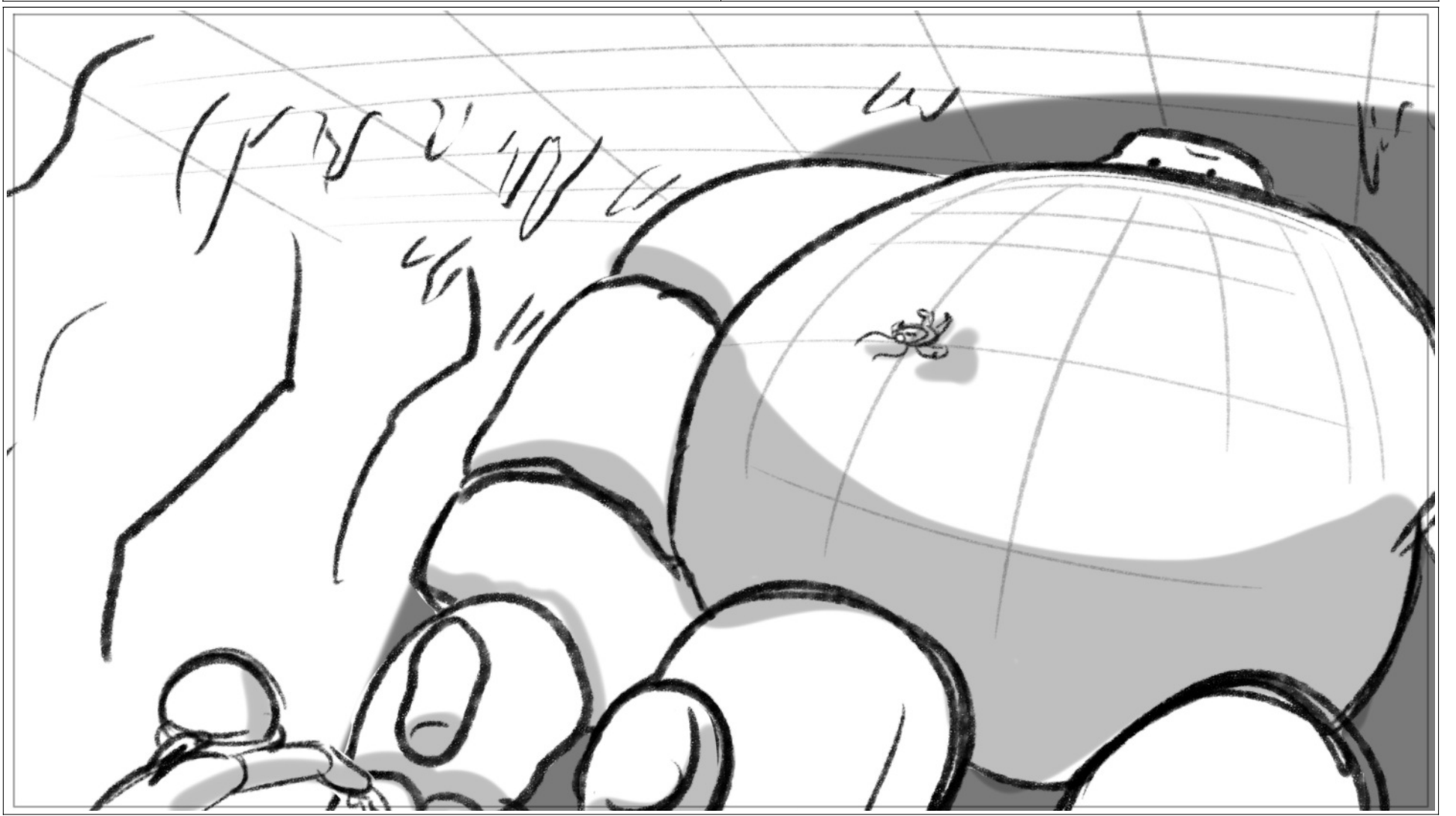

Scene	Panel
22	1

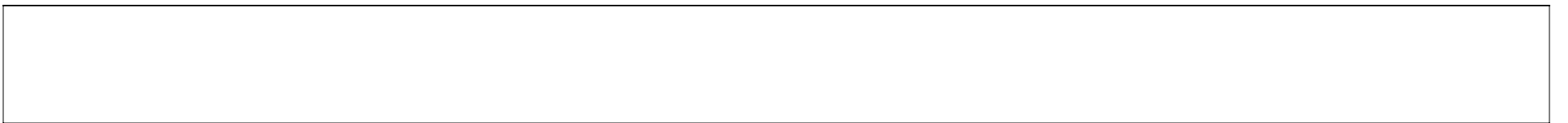
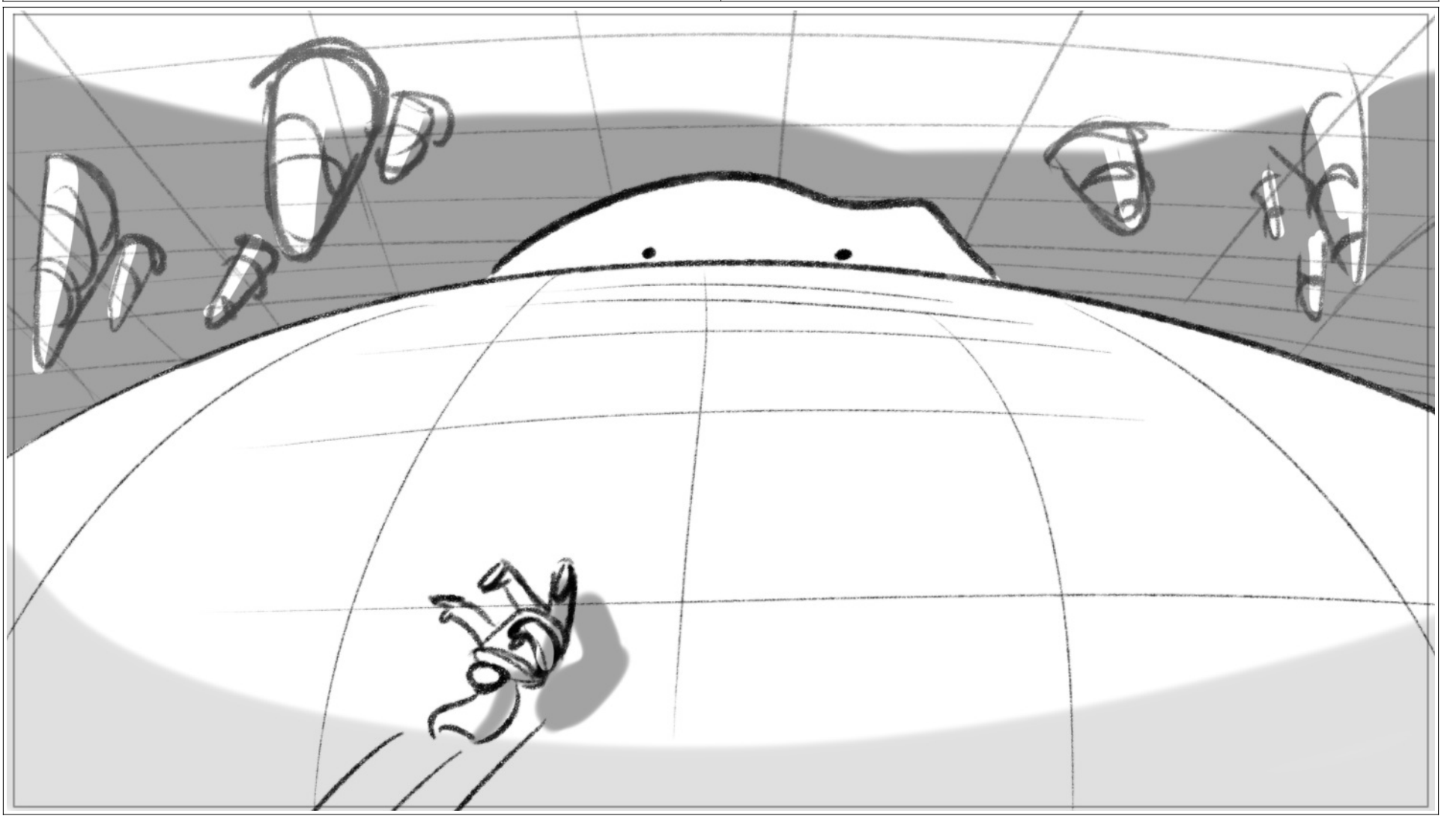

Scene	Panel
22	2

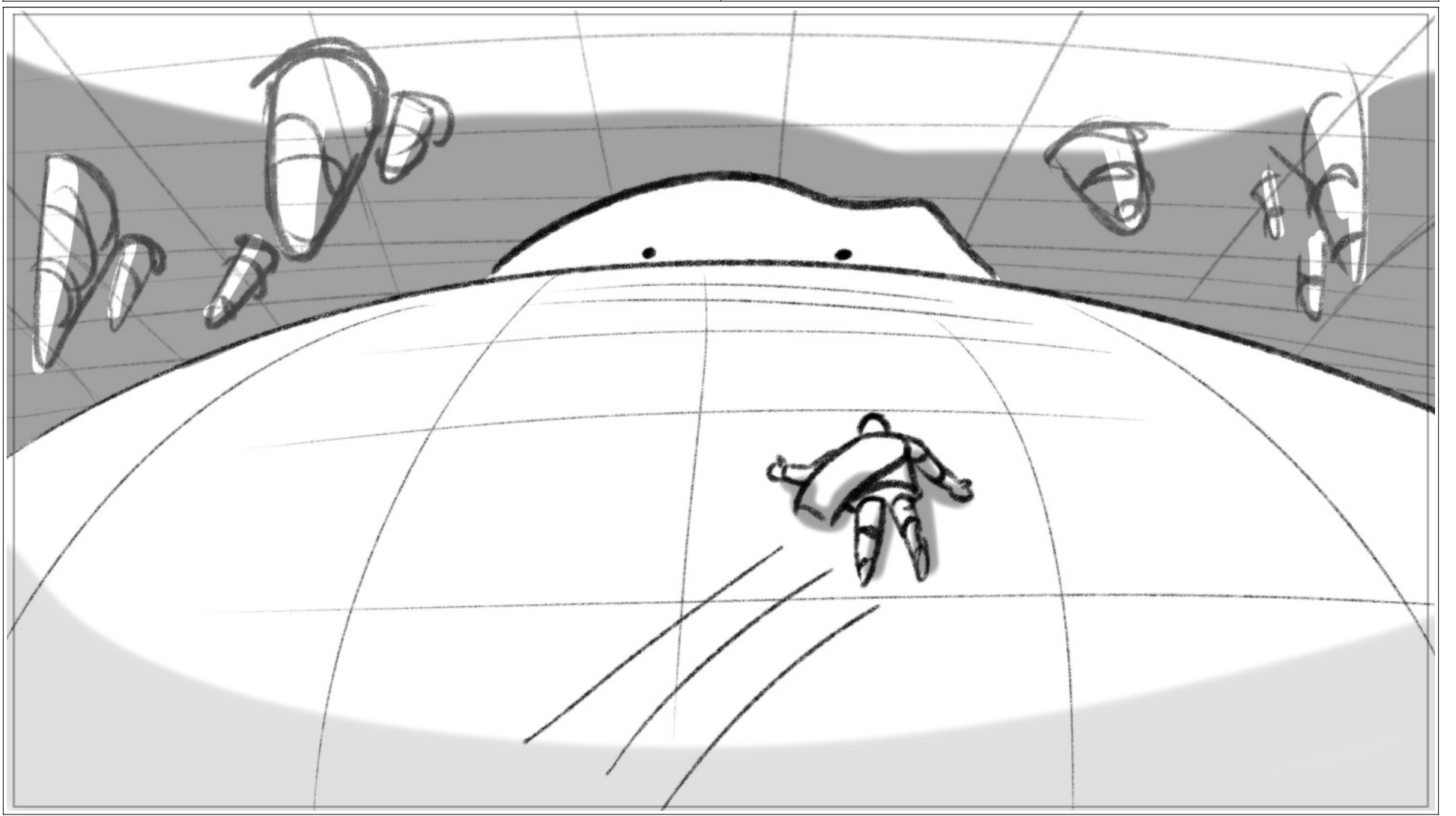

Empty space for notes or dialogue.

Scene	Panel
22	3

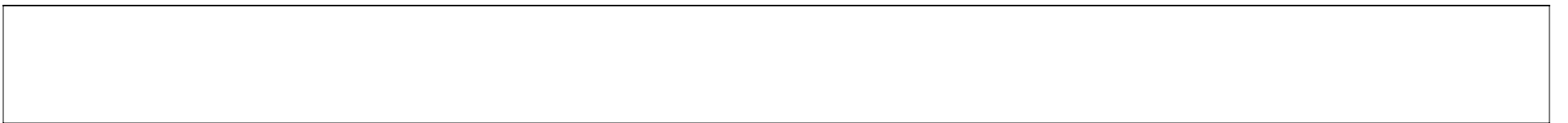
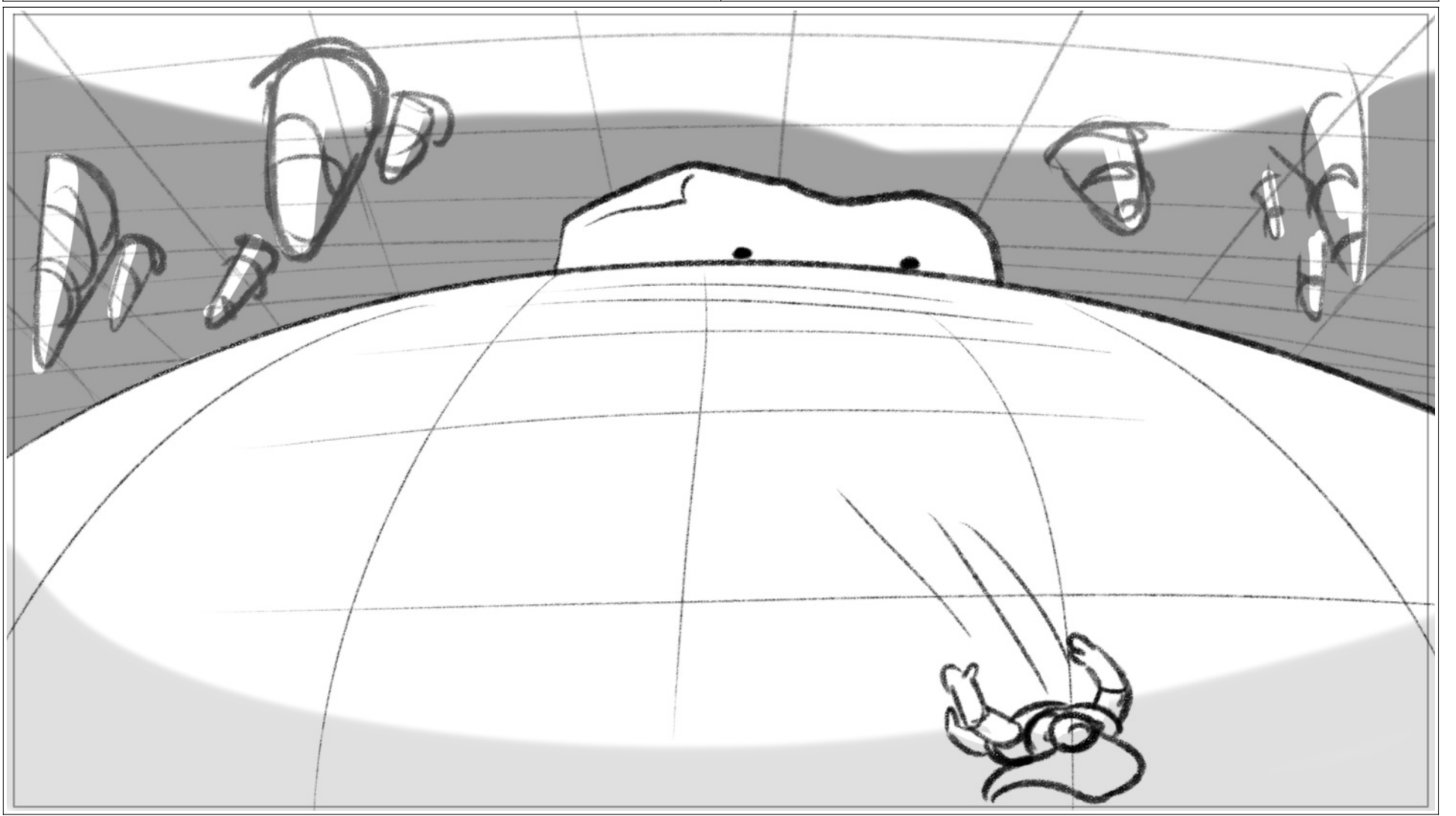

Scene	Panel
23	1

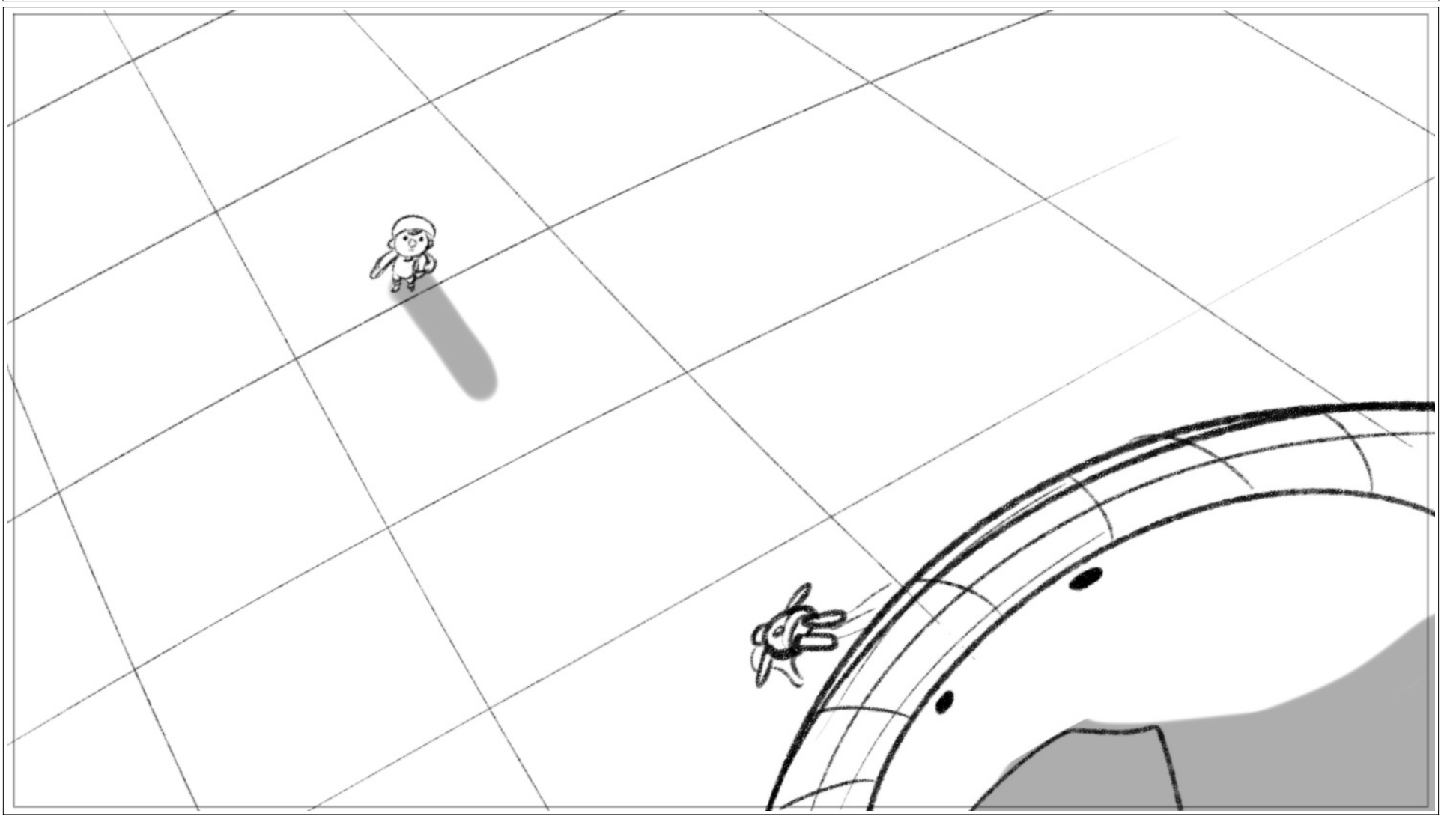

Empty space for notes or dialogue.

Scene	Panel
23	2

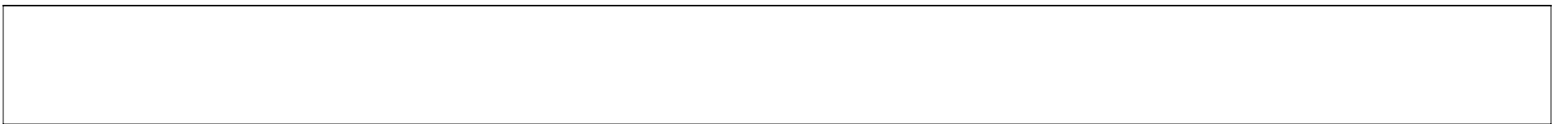
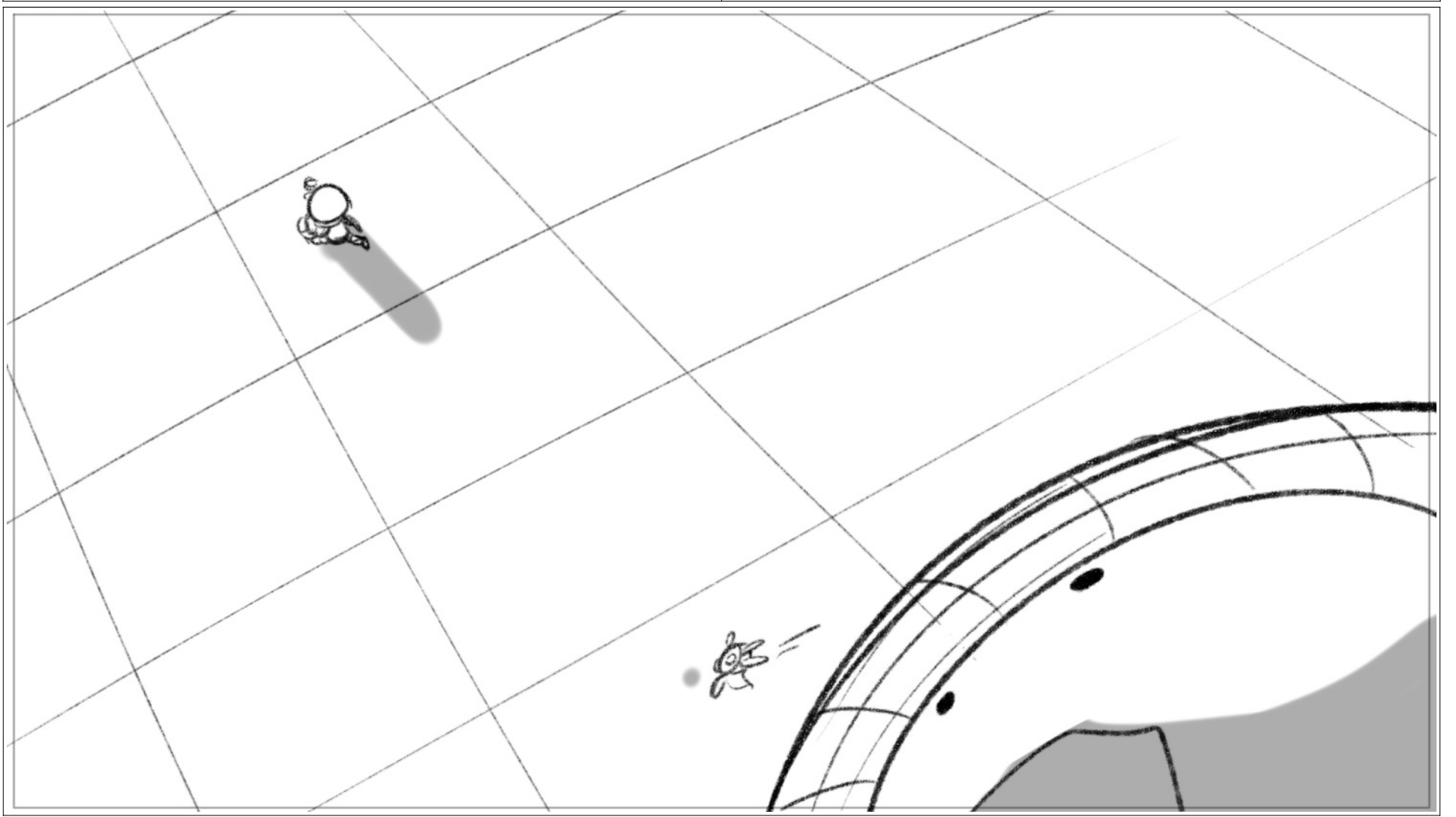

Scene	Panel
23	3

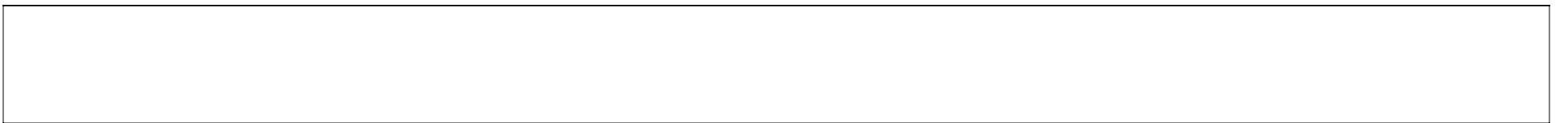
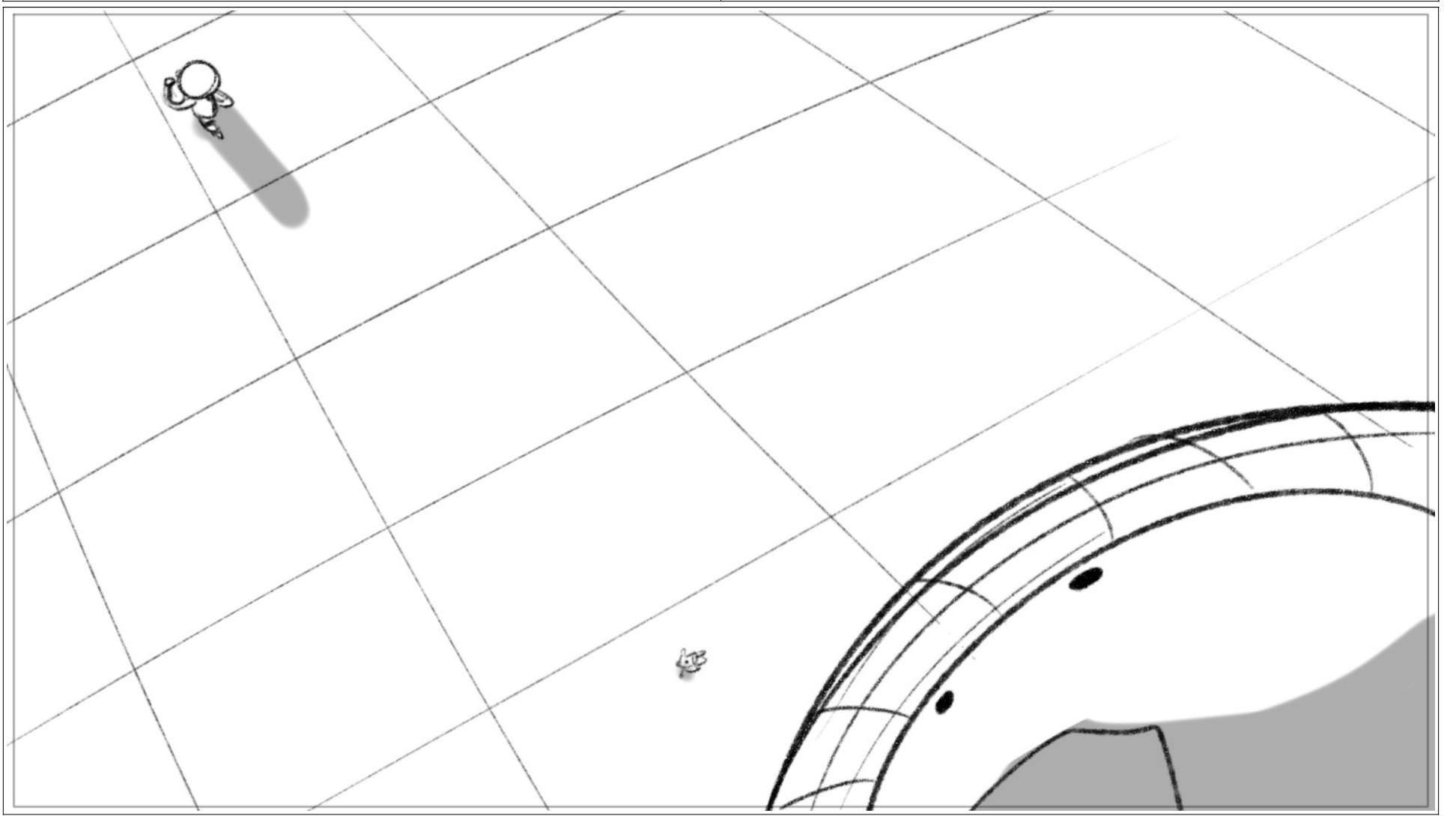

Scene	Panel
23	4

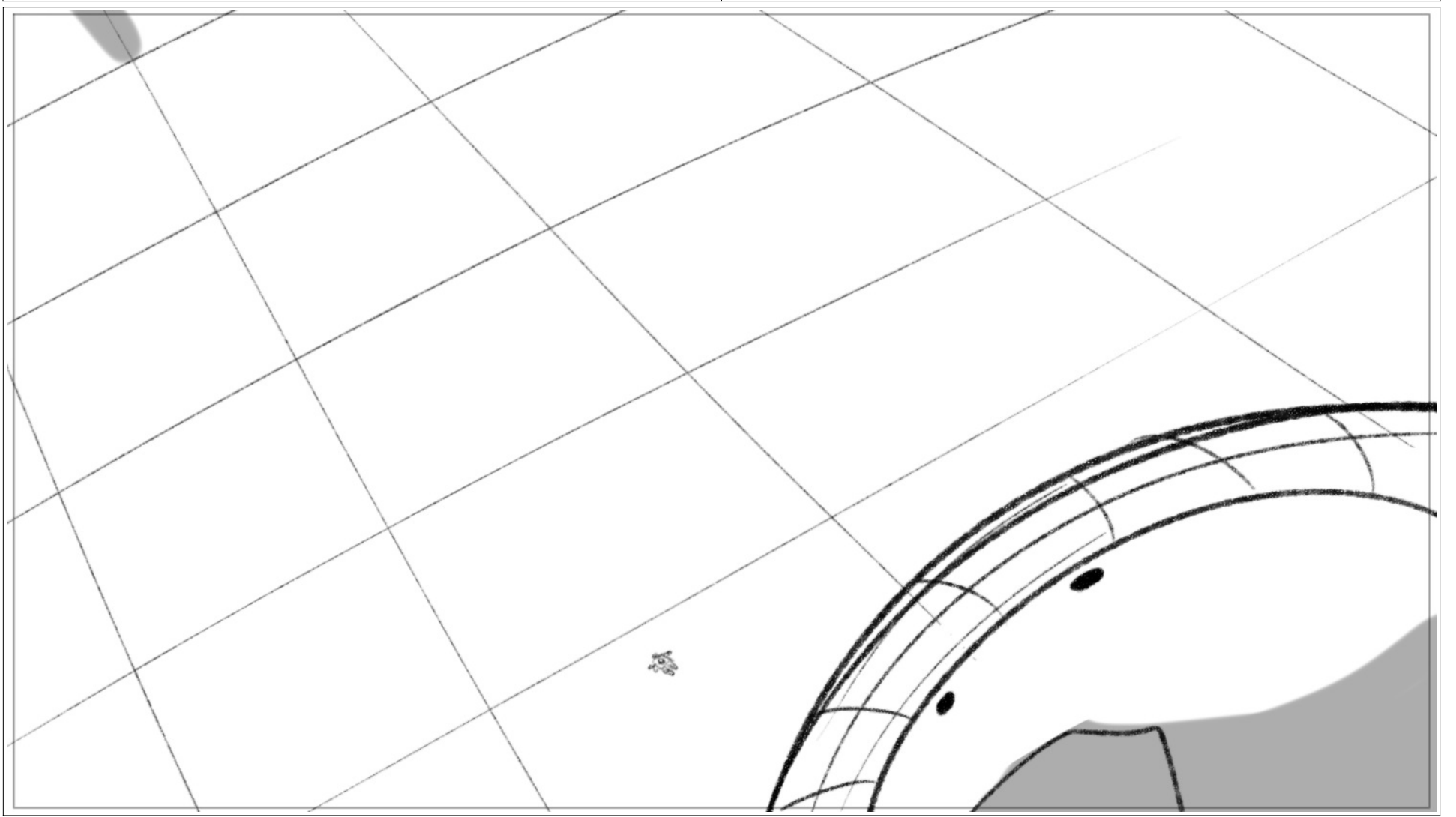

Empty space for notes or dialogue.

Scene 24	Panel 1
-------------	------------

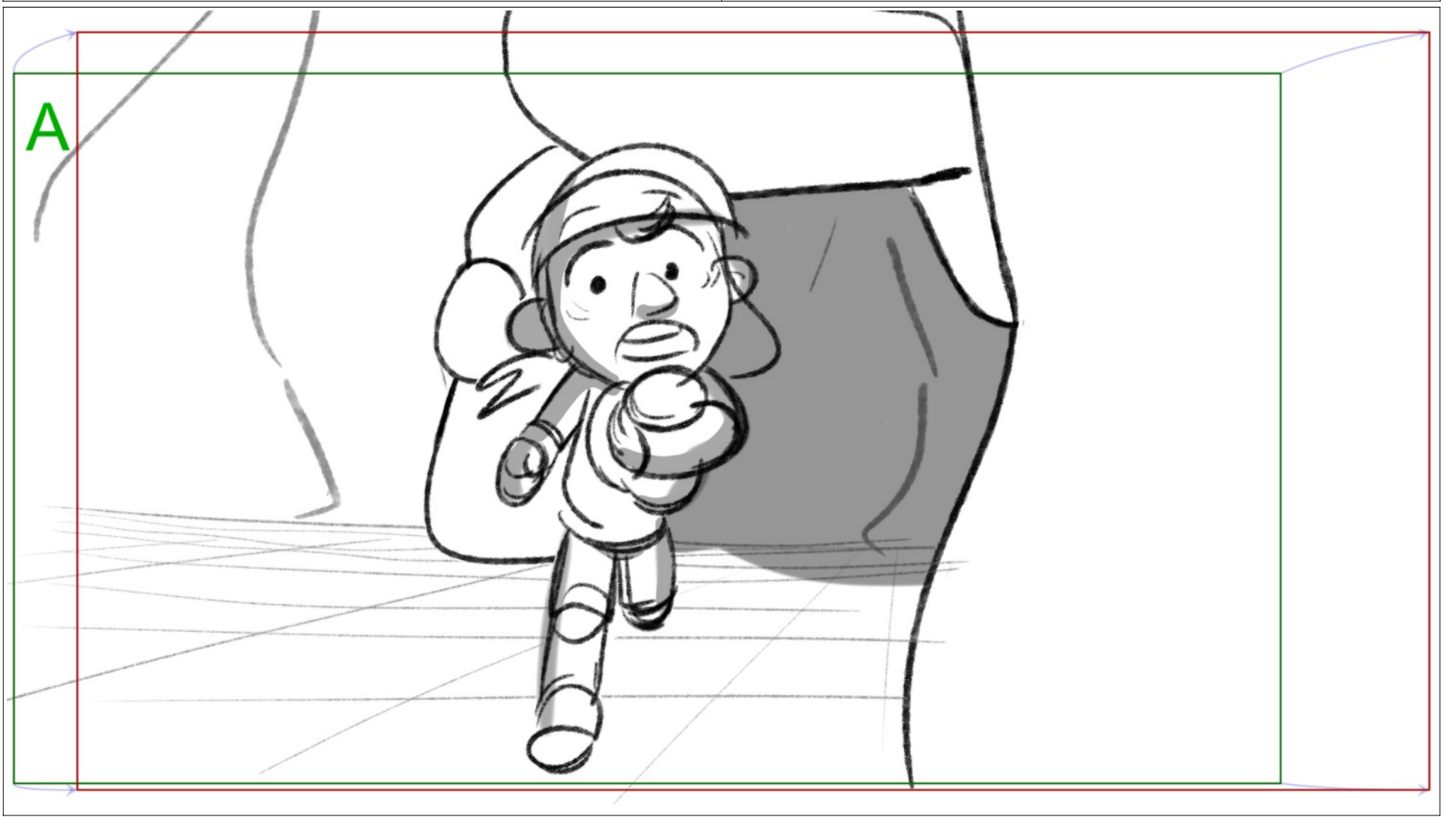

Scene	Panel
24	2



Scene	Panel
24	3

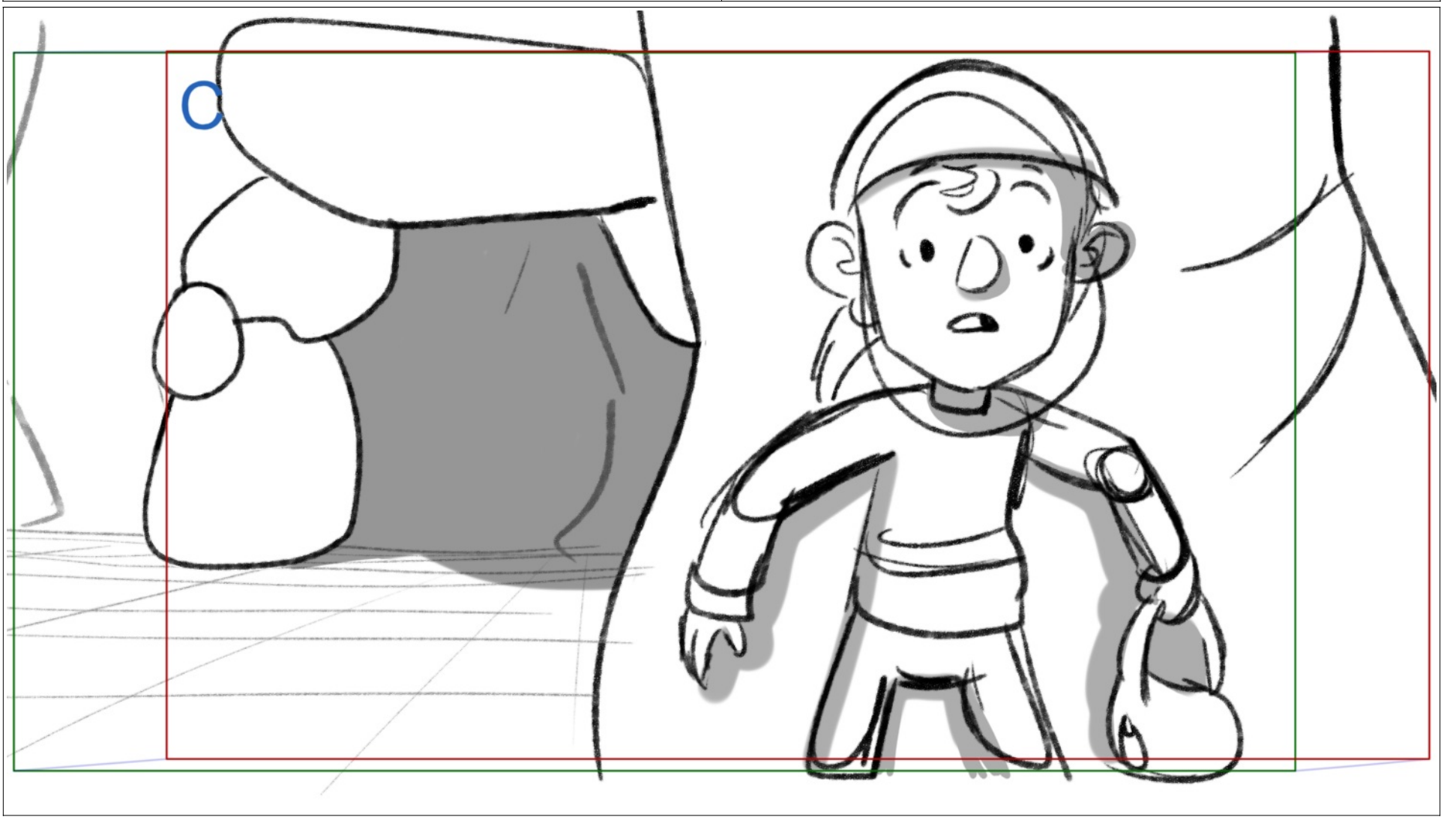

Scene	Panel
24	4



Scene	Panel
25	1

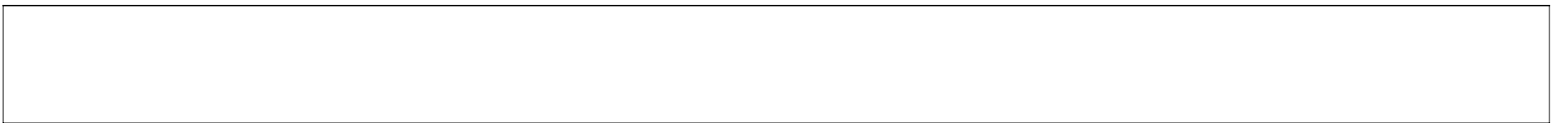
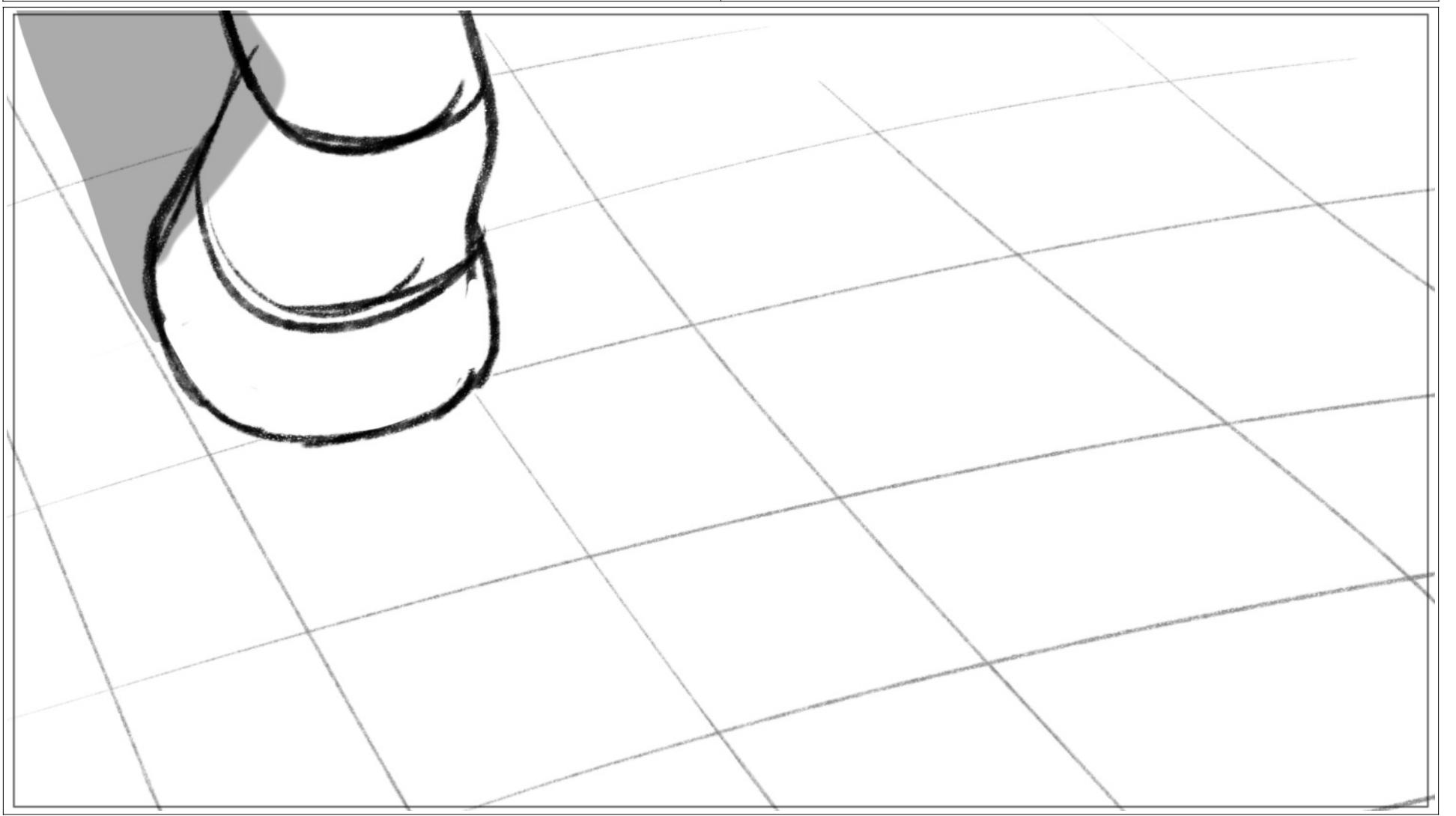

Scene	Panel
25	2

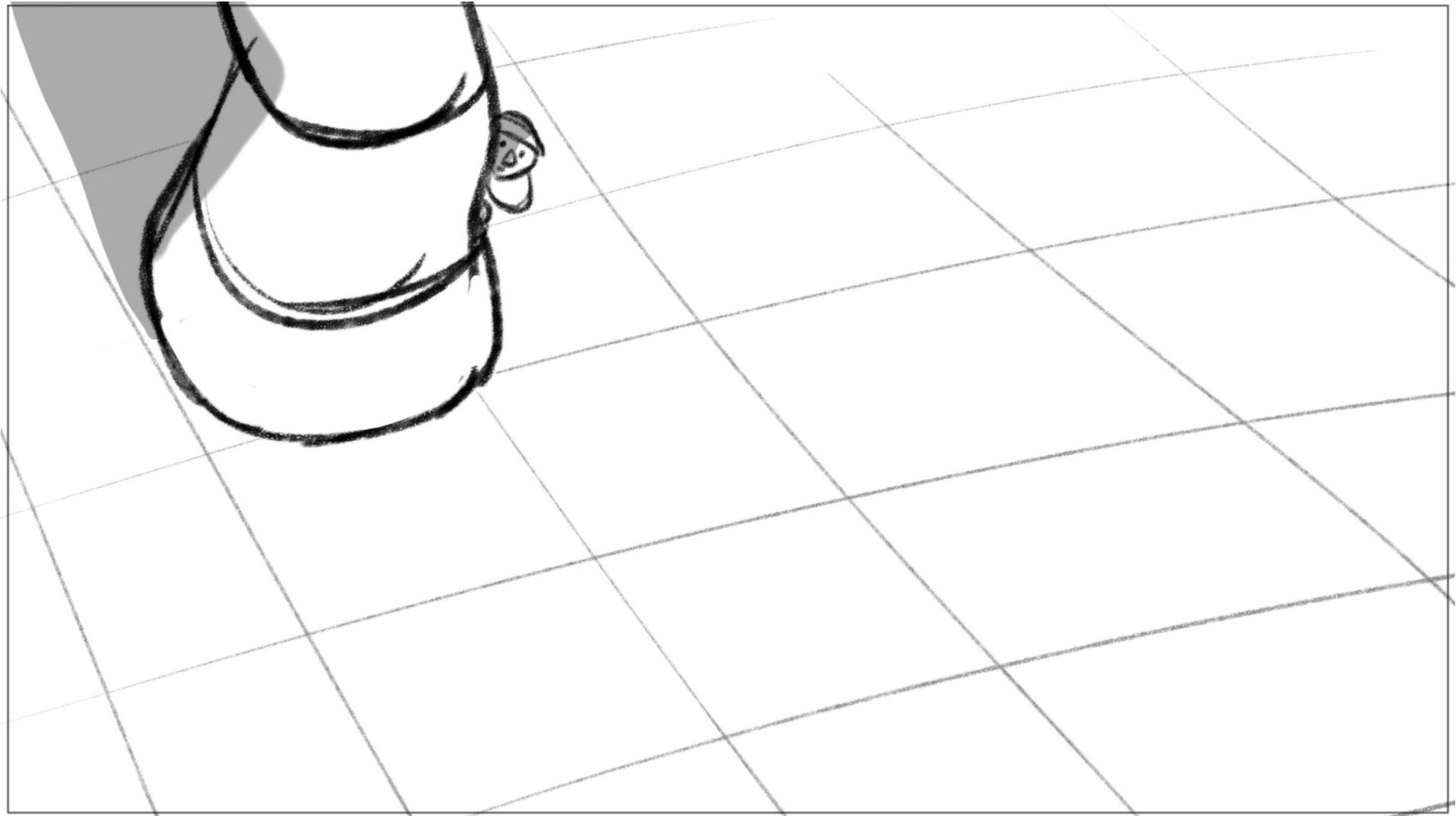

Empty rectangular box at the bottom of the page.

Scene 25	Panel 3
-------------	------------

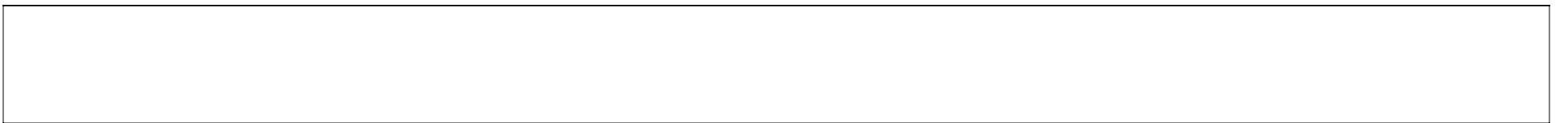
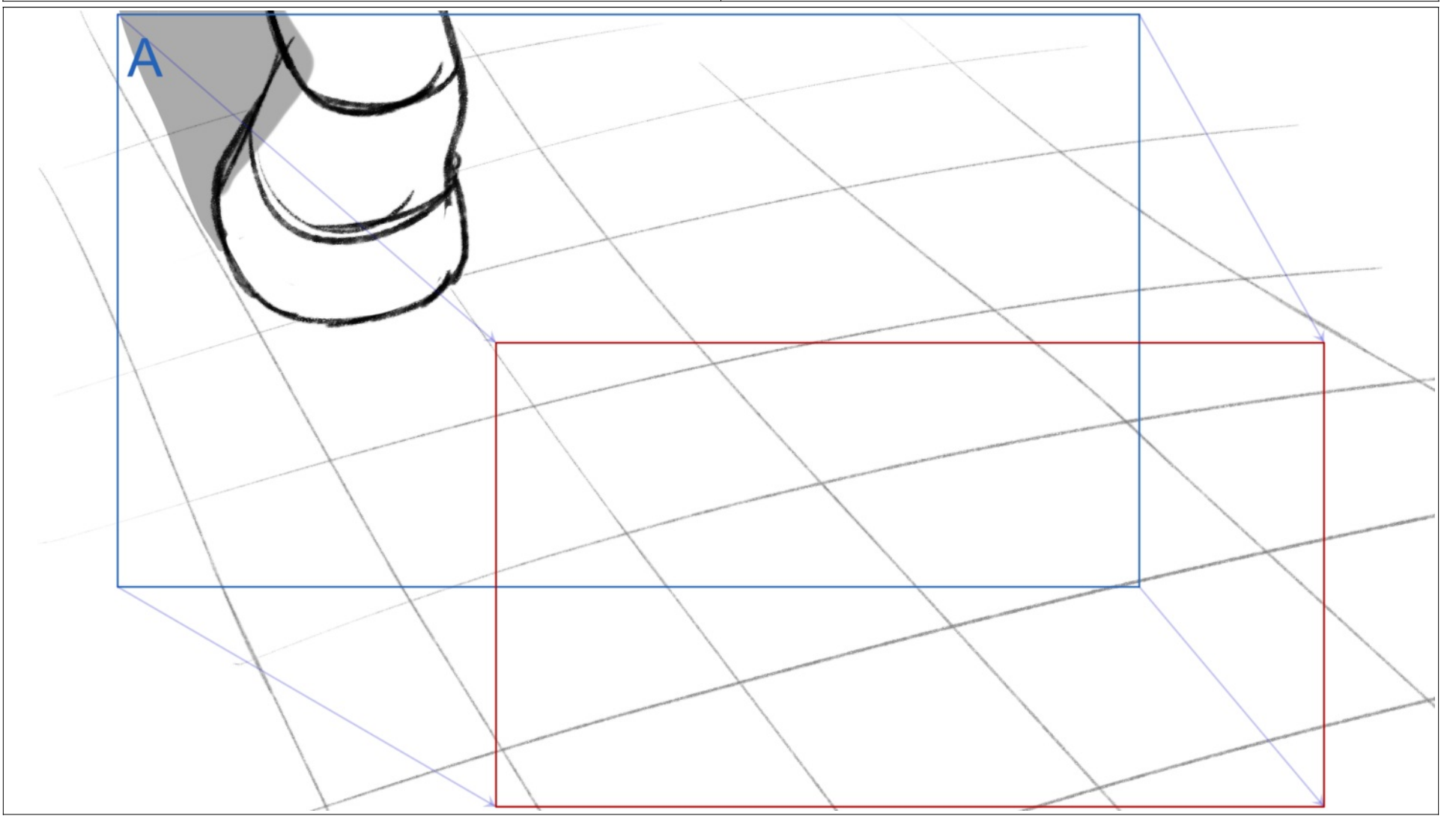

Scene	Panel
25	4

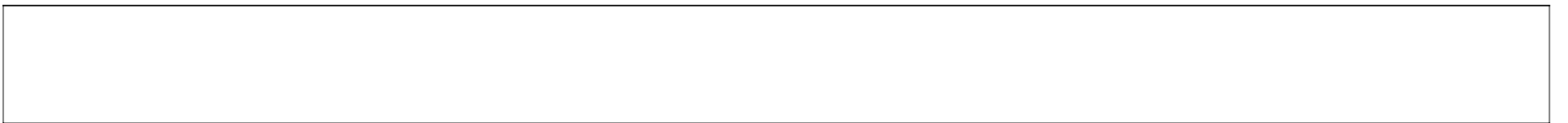
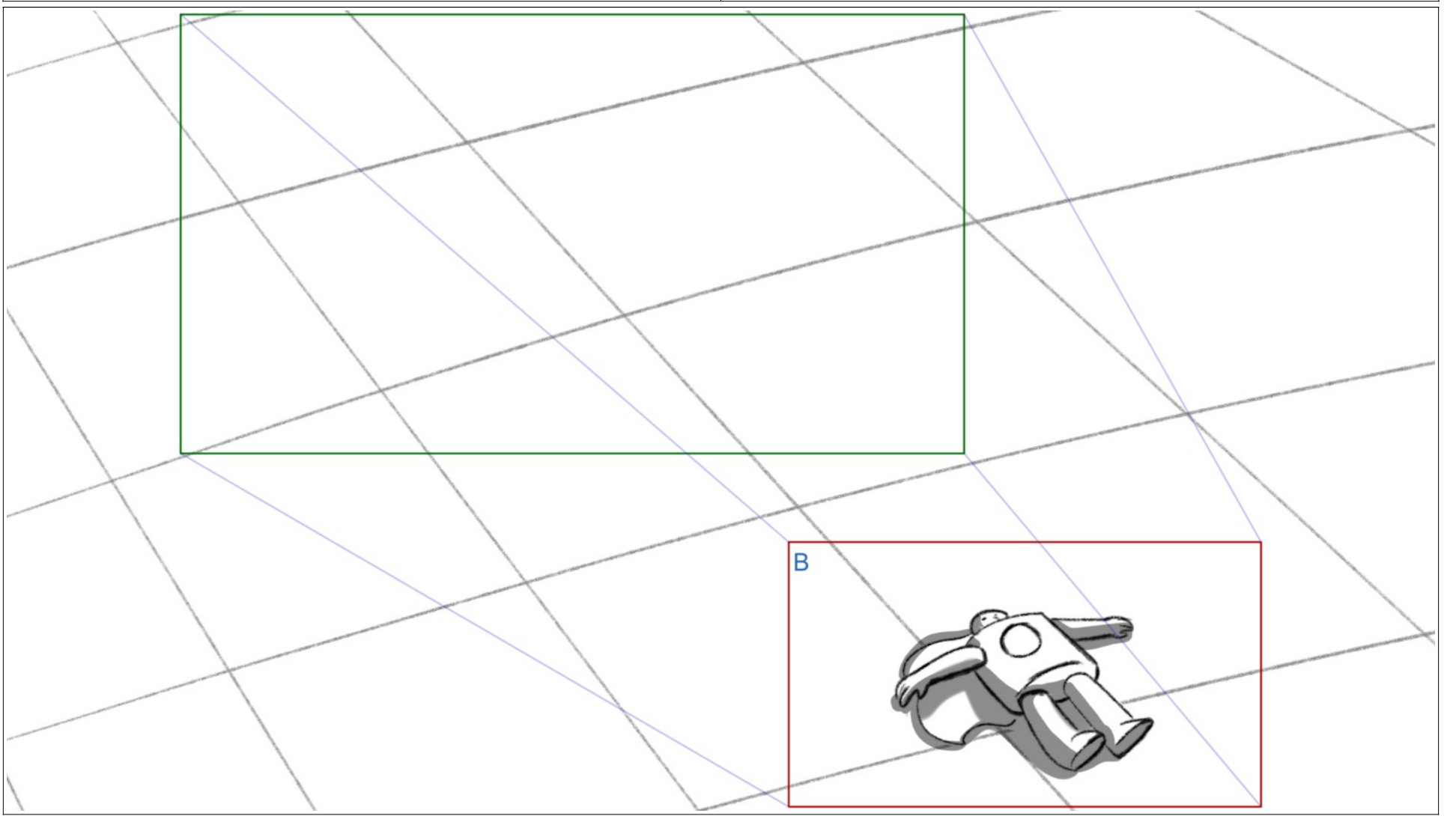

Scene	Panel
26	1

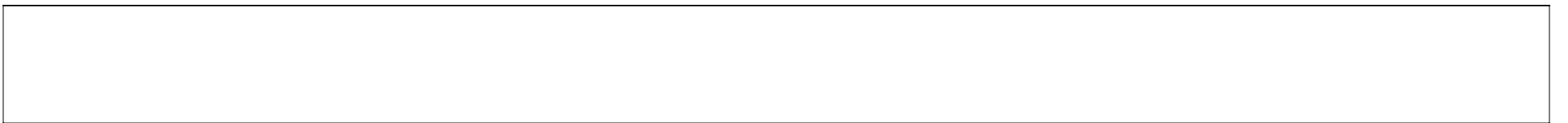
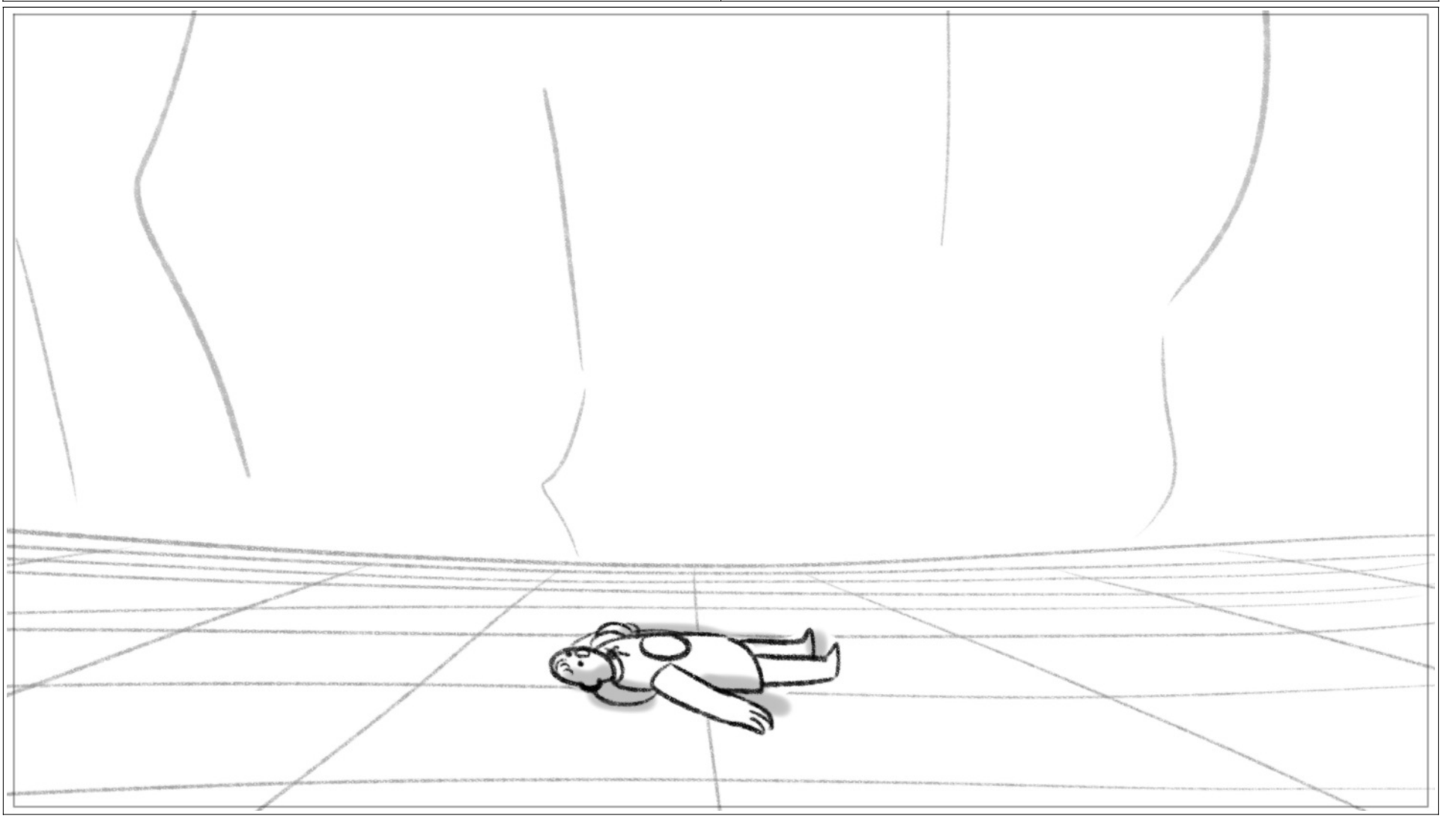

Scene	Panel
26	2

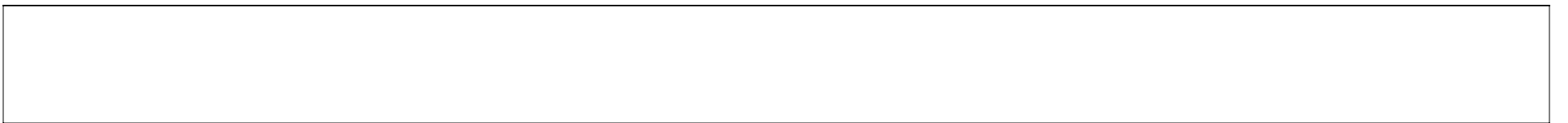
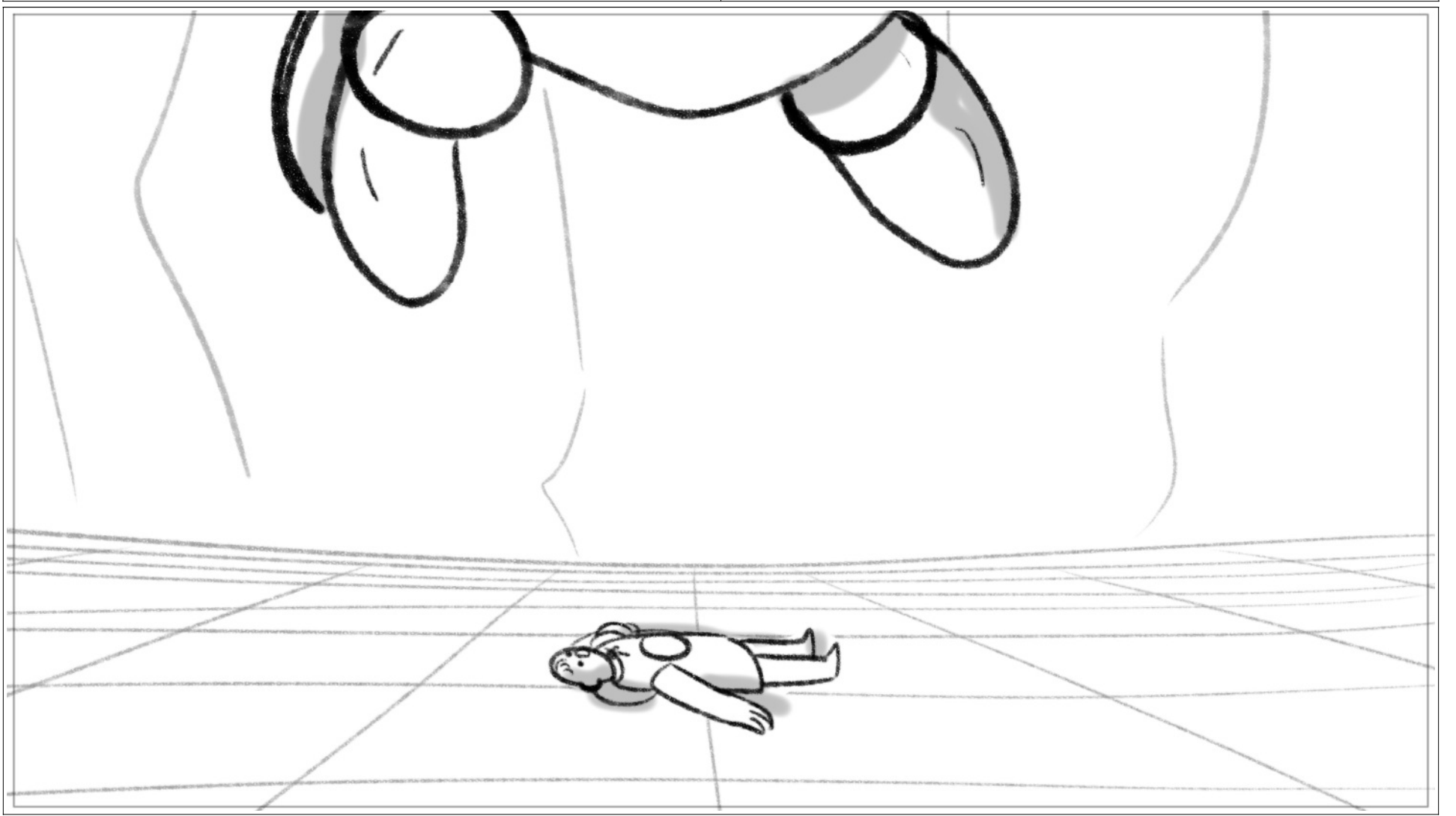

Scene	Panel
26	3

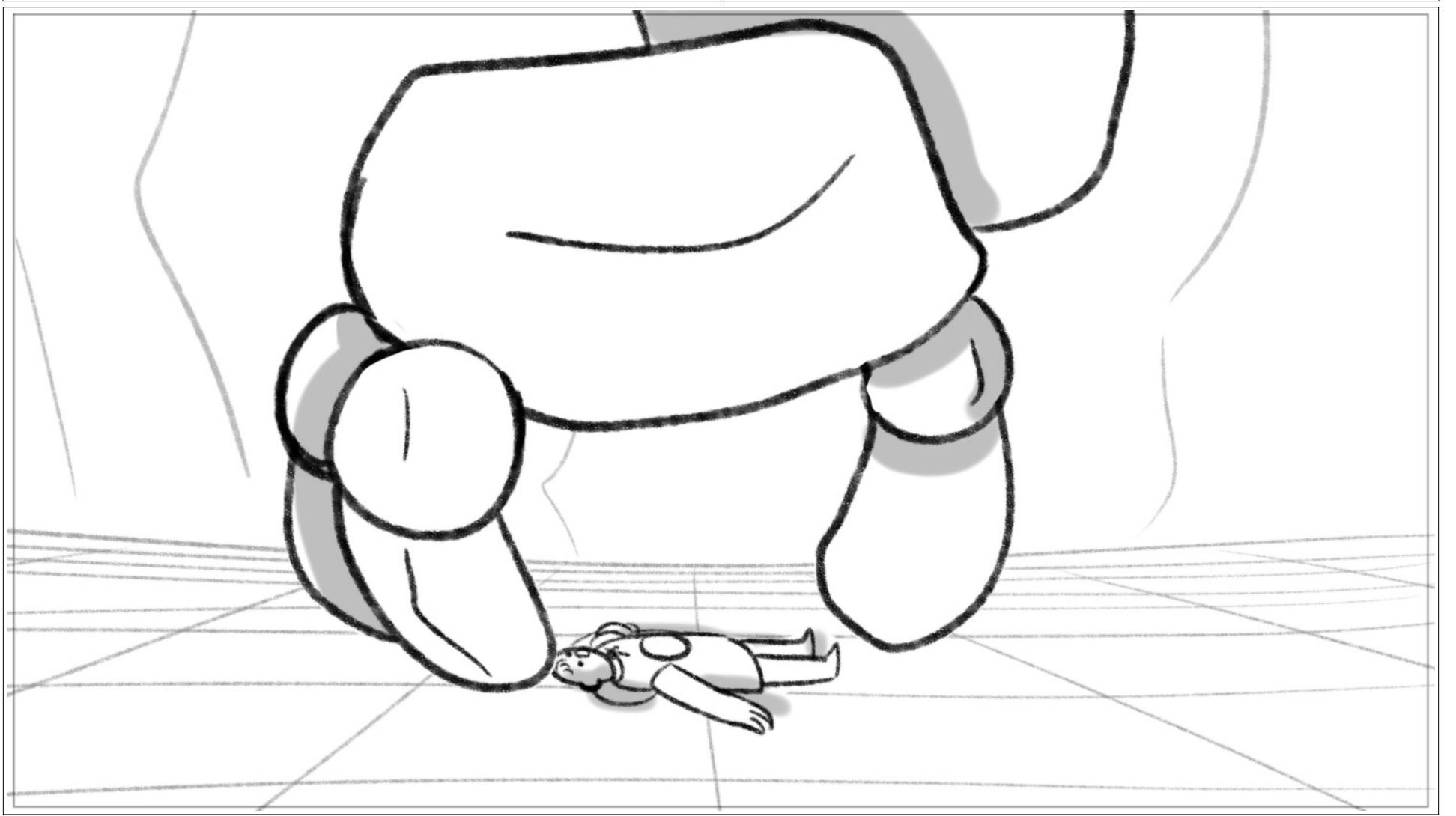

Scene	Panel
26	4

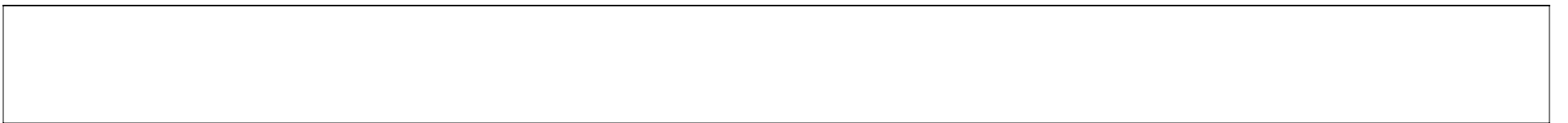
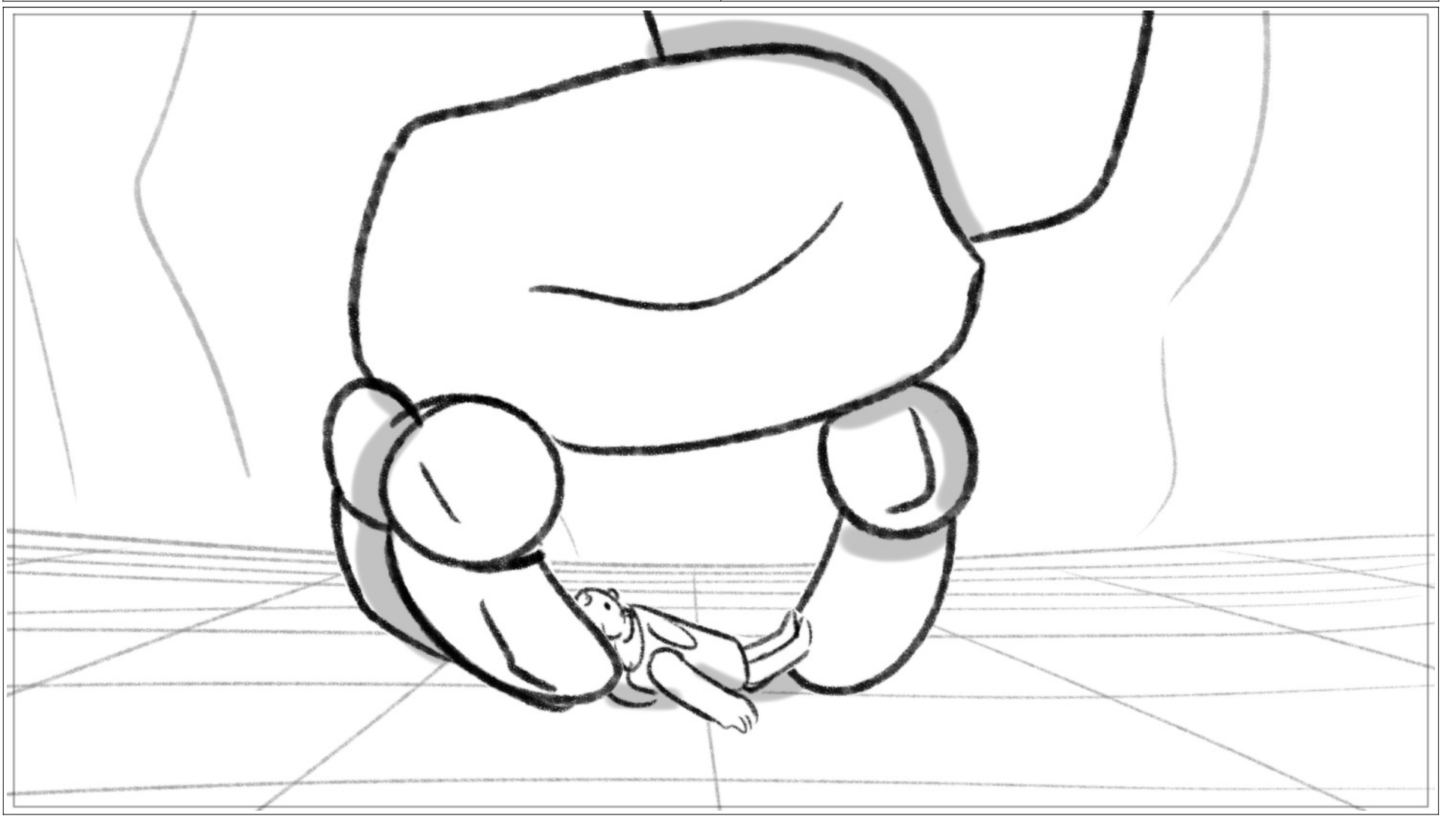

Scene 27	Panel 1
-------------	------------

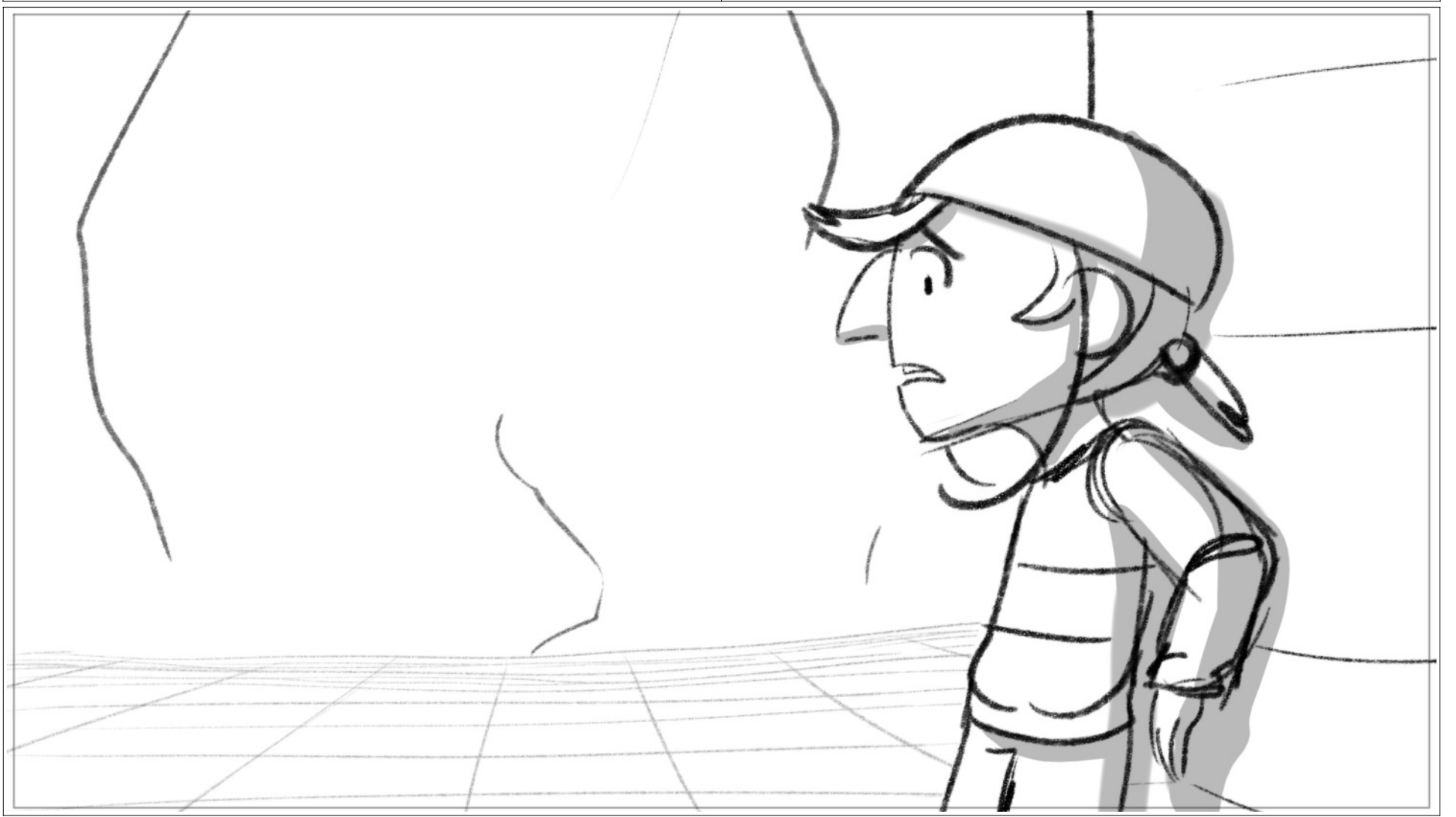

Scene	Panel
27	2

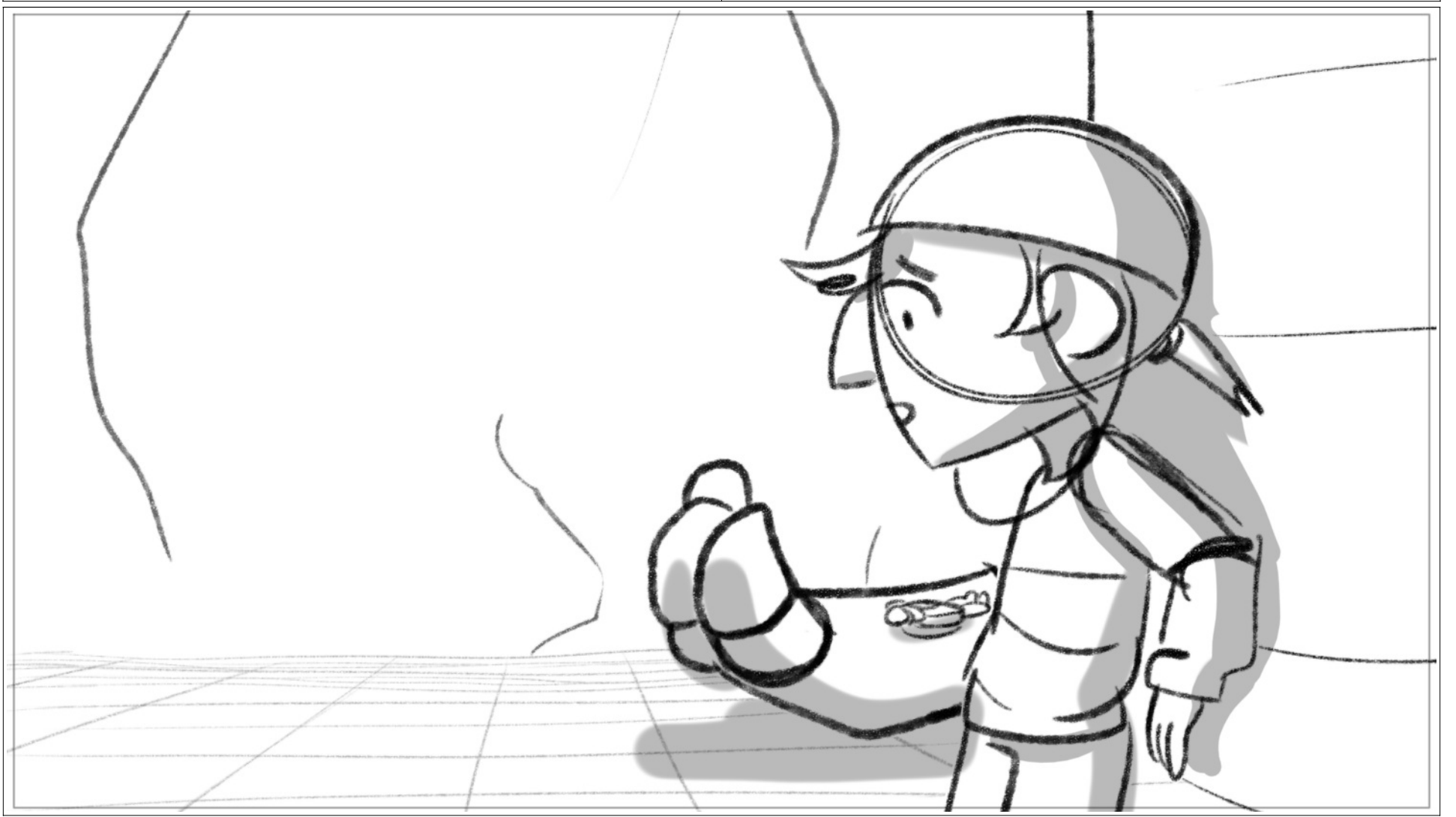

Scene	Panel
27	3

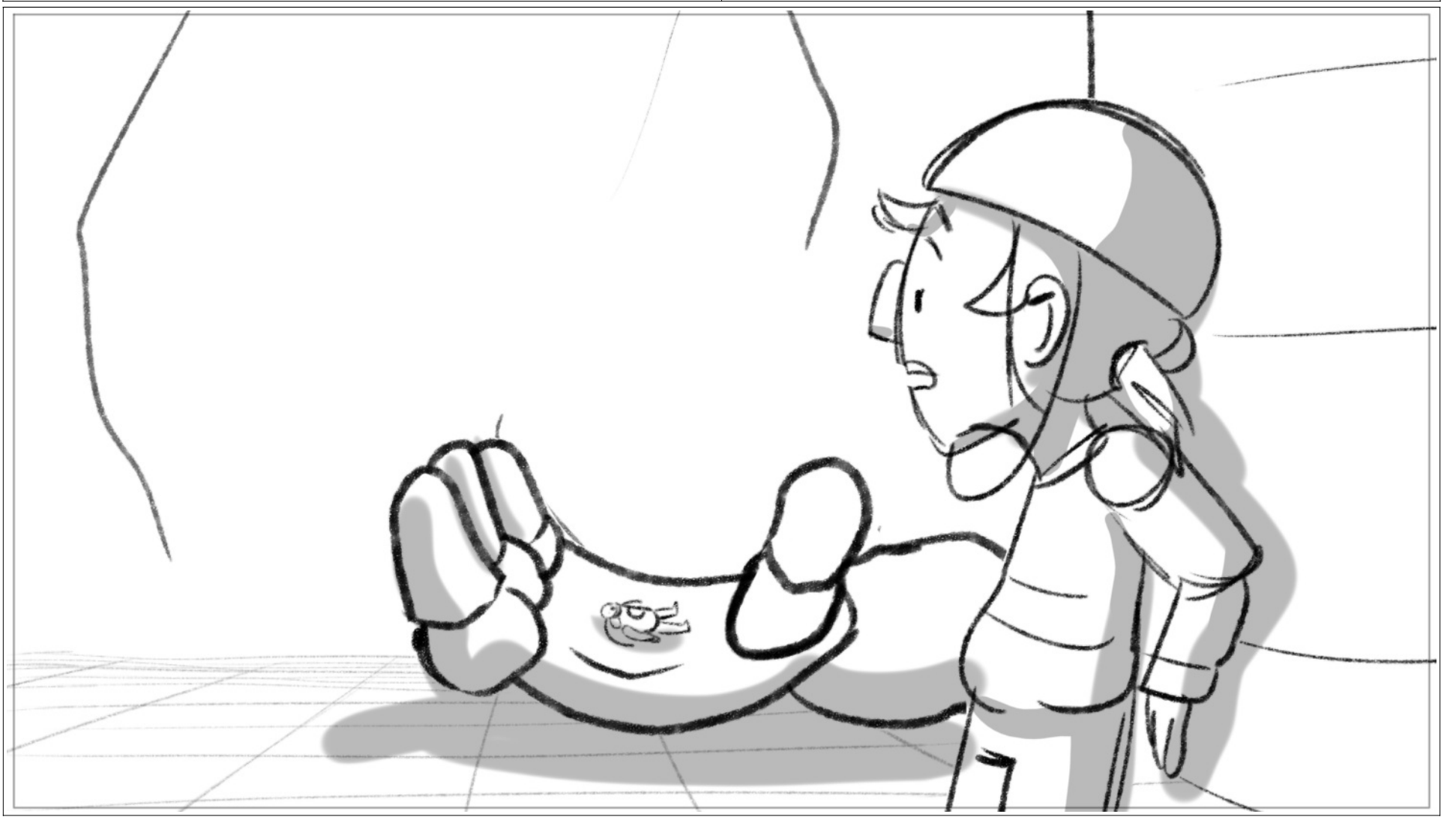

Scene	Panel
27	4

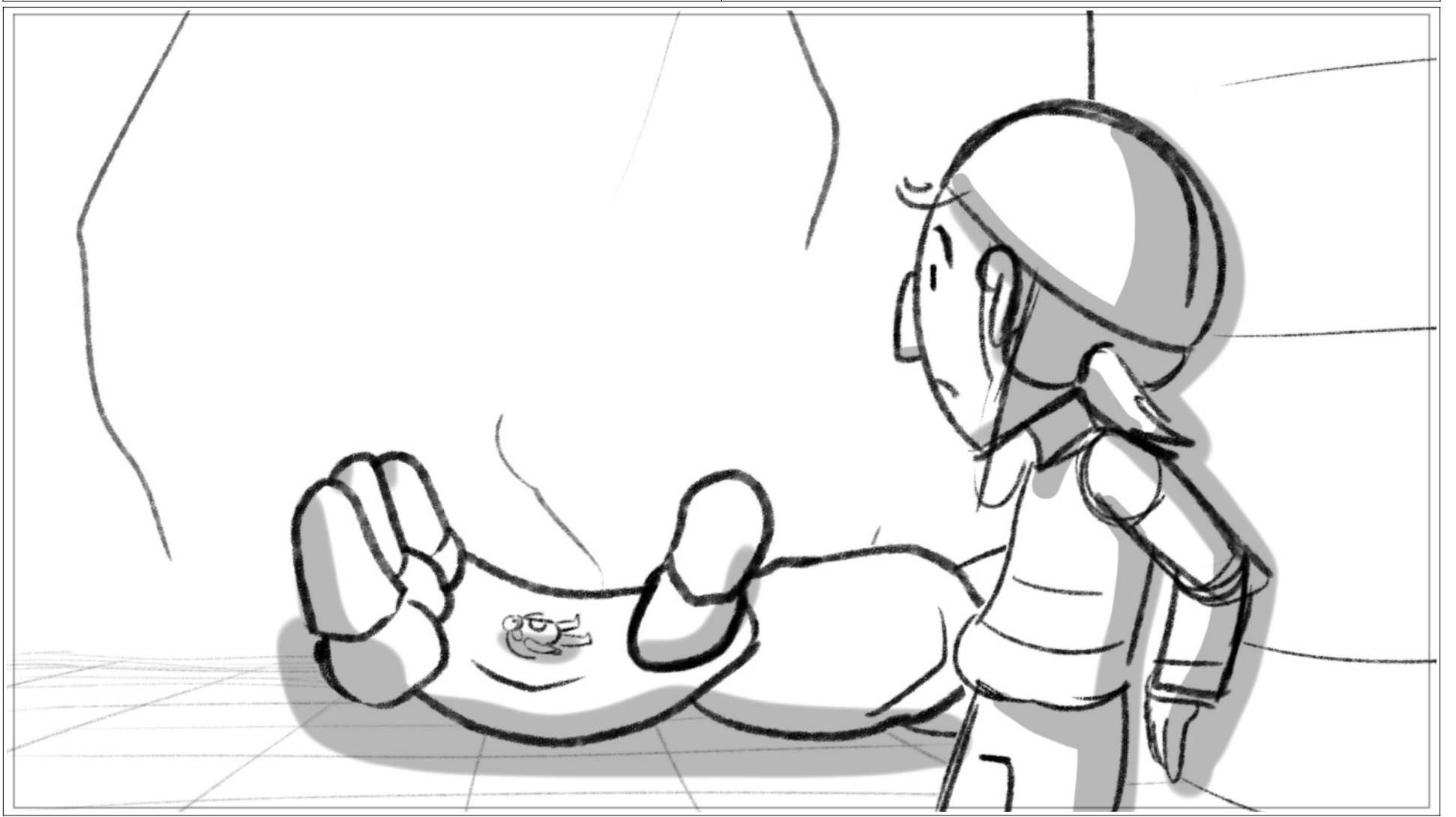

Scene	Panel
28	1

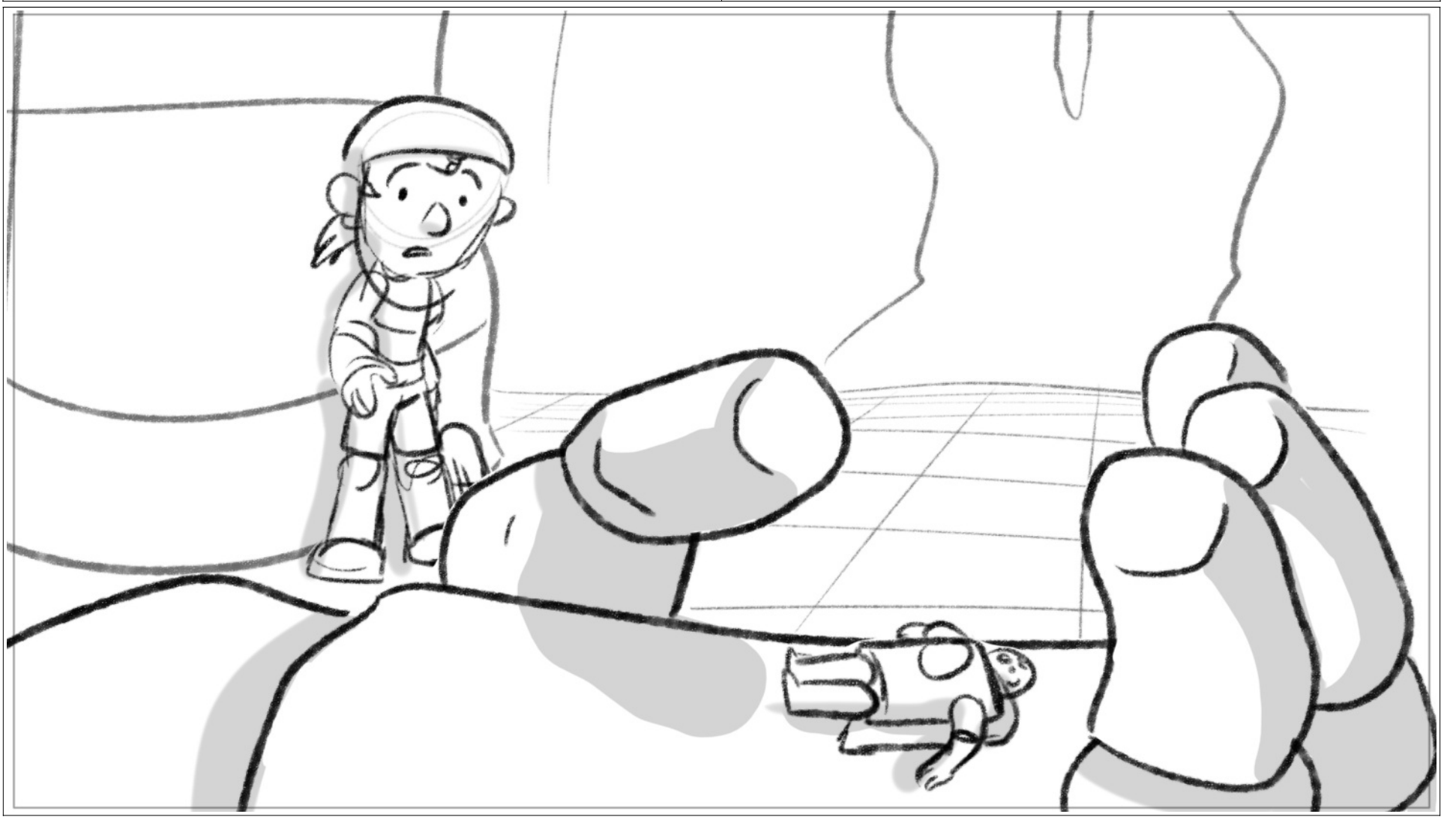

Scene	Panel
28	2

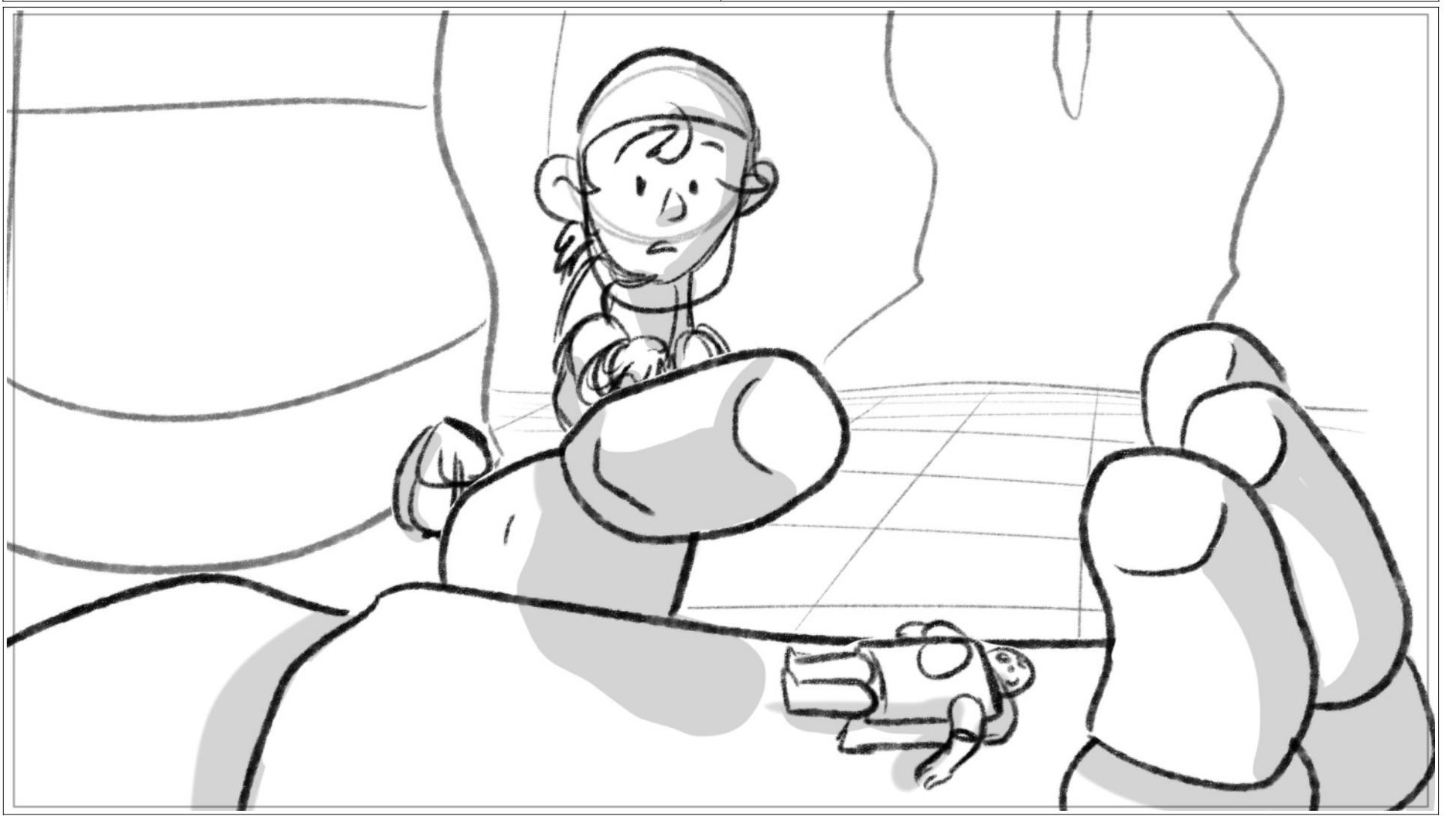

Scene	Panel
28	3

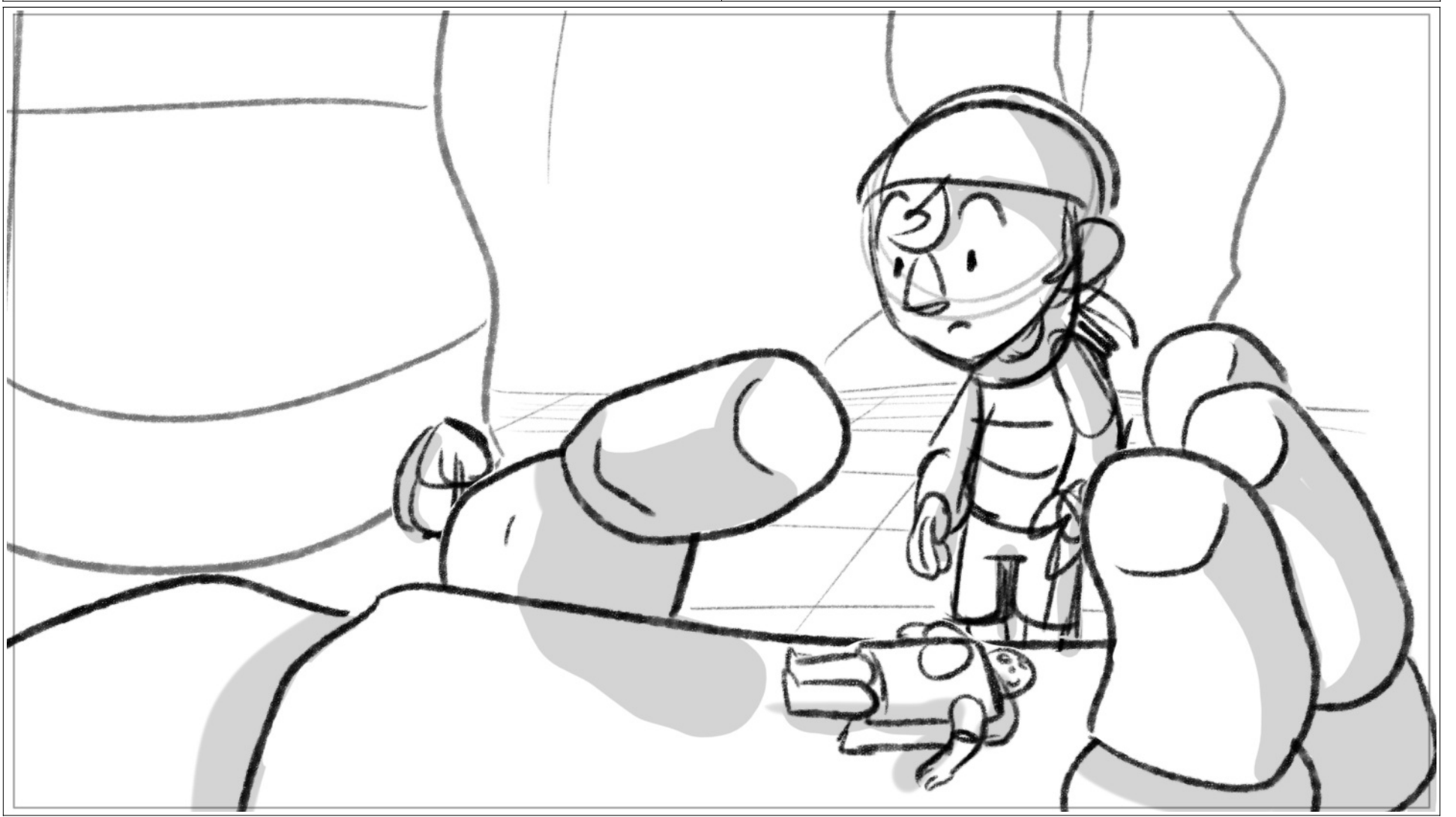

Scene 29	Panel 1
-------------	------------

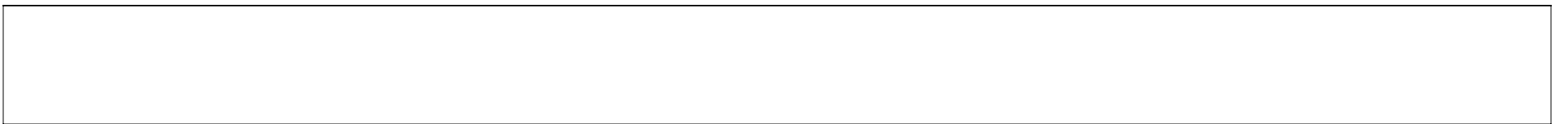
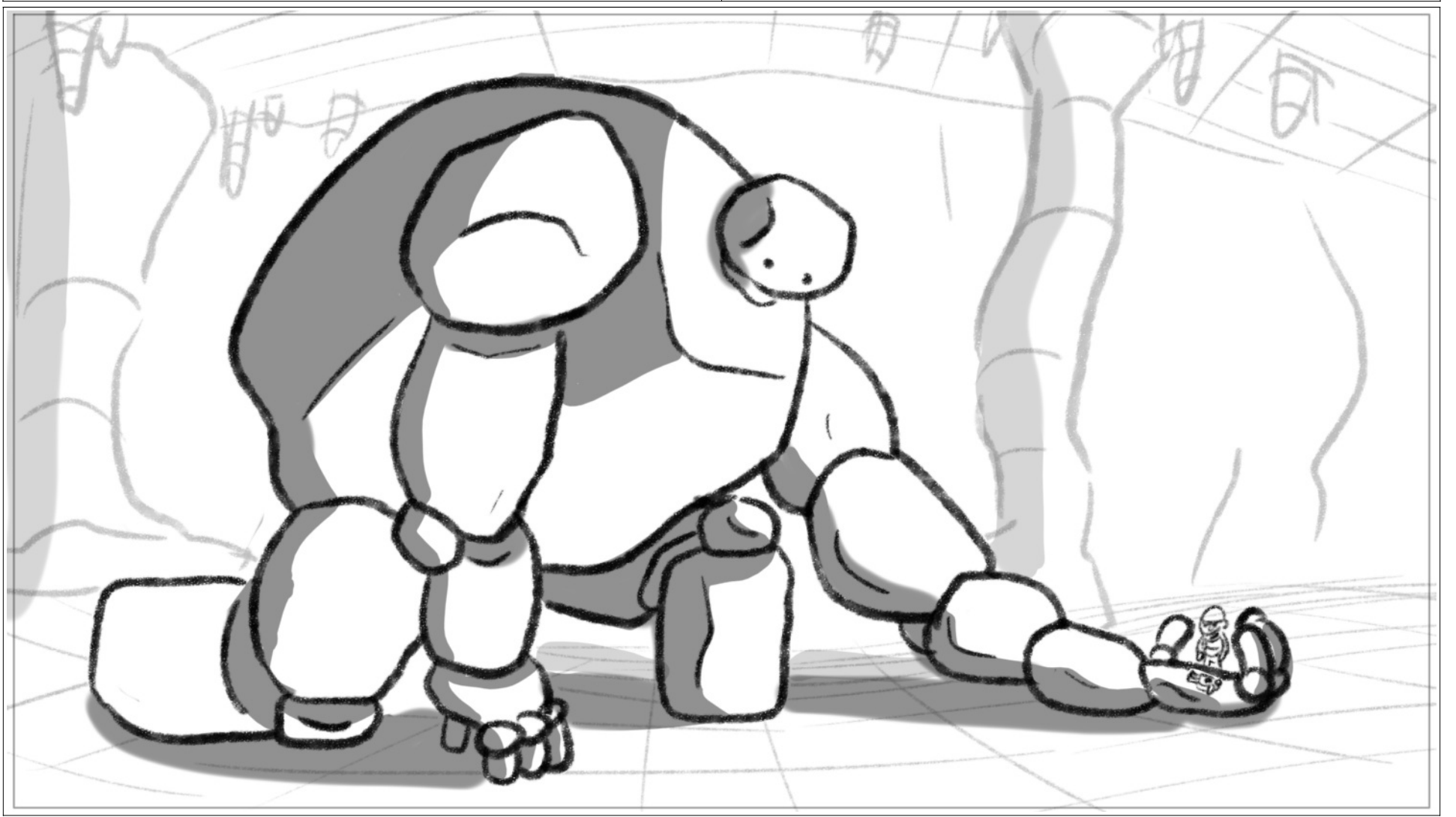

Scene 29	Panel 2
-------------	------------

